

THE UNITED REPUBLIC OF TANZANIA



MINISTRY OF WATER



Dar es Salaam Water Supply and Sanitation Authority

DAWASA Building, Dunga/Malaga Street, Mwananyamala Area

P. O. Box 1573, Dar es Salaam. TANZANIA.

Tel. +25522276006/15; Fax: +255222762480; E-mail: dawasaceo@dawasa.co.tz

**Comprehensive Project Brief for the Proposed Public Toilet to be built at
Magomeni Garden, Idrissa Mtaa, Magomeni Ward, Kinondoni Municipality
Dar es Salaam Region**

Submitted to:

National Environment Management Council,

Head Office, Kambarage Tower, 6th Floor, P. O. Box 2724, Dodoma.

Phone: +255 262960098, 0713608930,

Email Address: nemcdg@nemc.or.tz

Website: www.nemc.or.tz

Lead Consultant:

Prof. Rubhera RAM Mato (PhD), CEng. (T), Reg. EIA Expert

P. O BOX 35478, Dar es Salaam, Tanzania





Mobile: +255754898592; E-Mail: rubheramato@gmail.com

Submission date: 29th December 2022

ACKNOWLEDGEMENT

The Proponent (DAWASA) wishes to convey a heartfelt thanks and appreciation to all stakeholders who in one way or another supported the completion of this work. Thanks very much all of you. Special thanks to the Kinondoni Municipal Council Officers for their prompt assistance during the fieldwork. Last but not least we thank the local community and wards leaderships in the project vicinity for their cooperation. Also, appreciation for all experts and assistants participated on data collection and preparation of the report.

THE STUDY TEAM

NAME	POSITION	NEMC Reg. No.	SIGNATURE
Prof. Rubhera RAM Mato	Environmental and ESIA Team Leader	Registered NEMC/EIA/0092	
Mr. Robert Kishiki	Sociologist	Not Registered	
Mr. Emmanuel Rajab	Environmental Engineer	Registered EC/EE- EIA/2021/0015	
Mr. Melkizedeck Stephano	Environmentalist	Not Registered	

ABBREVIATIONS

AAQ	Ambient Air Quality
AIDS	Acquired Immuno-Deficiency Syndrome
DAWASA	Dar es Salaam Water Supply and Sanitation Authority
EIA	Environmental Impact Assessment
EMP	Environmental Management Plan
ESIA	Environmental and Social Impact Assessment
ESMP	Environmental and Social Monitoring Plan
GoT	Government of Tanzania
HIV	Human Infection Virus
IDA	International Development Association
LGA	Local Government Authority
NEMC	National Environment Management Council
NEP	National Environment Policy
OGSP	Off-Grid Sanitation Project
PPE	Personal Protective Equipment
PVC	Polyvinyl Chloride
RAP	Resettlement Action Plan
STDS	Sexual Transmitted Diseases

TABLE OF CONTENTS

ACKNOWLEDGEMENT	I
THE STUDY TEAM	II
ABBREVIATIONS	III
EXECUTIVE SUMMARY	IX
1.0 BACKGROUND AND JUSTIFICATION	1
2.0 NATURE OF THE PROJECT	3
3.0 PROJECT DESCRIPTION	3
3.1 PROJECT LOCATION	3
3.2 ACCESSIBILITY	5
3.3 SPECIFIC FEATURES	5
3.4 ADJACENT LAND USE	6
3.4.1 LAND OWNERSHIP	6
3.5 BASELINE INFORMATION	7
3.5.1 WATER TABLE AND WATER QUALITY ANALYSIS	7
3.5.2 AIR QUALITY	7
3.5.3 NOISE LEVELS	7
3.5.4 CLIMATE	8
4.0 POLICIES, LEGISLATION AND INSTITUTIONAL ASPECT	8
4.1 RELEVANT POLICIES	9
4.1.1 <i>National Environment Policy 2021</i>	9
4.1.2 <i>National Land Policy of 1997</i>	9
4.1.3 <i>Construction Industry Policy (2003)</i>	9
4.1.4 <i>National Health Policy (2003)</i>	10
4.1.5 <i>National Gender Policy of 2000</i>	10
4.1.6 <i>National Human Settlements Development Policy (2000)</i>	11
4.2 PRINCIPAL LEGISLATIONS AND REGULATIONS	11
4.2.1 <i>Environmental Management Act (2004)</i>	11
4.2.2 <i>The Environmental Management (Fees and Charges) Regulations, 2021</i>	12
4.2.3 <i>The Environmental Management (Control of hazardous Waste)</i> <i>regulations, 2021</i>	13
4.2.4 <i>The Environmental Management (Control of Noise and vibration)</i> <i>regulations, 2015</i>	13
4.2.5 <i>The Environmental Management (Prohibition of Plastic Carrier bags)</i> <i>regulations, 2019</i>	13
4.2.6 <i>The Environmental Management (Solid Waste Management) regulations,</i> <i>2007</i>	14
4.2.7 <i>The Environmental Management (Water Quality) regulations, 2009</i>	14
4.2.8 <i>The Environmental Management (Air Quality) regulations, 2009</i>	15
4.2.9 <i>The Environmental Management (Soil Quality) regulations, 2009</i>	15
4.2.10 <i>Occupational Health and Safety Act 2003</i>	16
4.2.11 <i>Water Supply and Sanitation Act No. 12 of 2009</i>	16
4.2.12 <i>Engineers Registration Act and its Amendments 1997 and 2007</i>	17
4.2.13 <i>Contractors Registration (Amendment) Act, 2008</i>	17
4.2.14 <i>Architects and Quantity Surveyors Act (1997)</i>	17
4.2.15 <i>Urban Planning Act (2007)</i>	17
4.2.16 <i>Public Health Act (2009)</i>	18
5.0 PROJECT ACTIVITIES	19

5.1	MOBILIZATION OR PRE-CONSTRUCTION PHASE.....	19
5.2	CONSTRUCTION PHASE	20
5.3	DEMOBILIZATION PHASE	21
5.4	OPERATION PHASE	21
5.5	DECOMMISSIONING PHASE.....	22
6.0	PROJECT DESIGN	22
6.1	TOILET DESIGN	22
6.2	LAYOUT PLAN	23
7.0	PROJECT REQUIREMENTS AND WASTE GENERATION.....	25
7.1	PROJECT REQUIREMENTS	25
7.1.1	<i>Construction materials and labour force</i>	25
7.1.2	<i>Labour force</i>	26
7.1.3	<i>Machinery and Equipment</i>	26
7.2	WASTES GENERATION	27
6.2.1	LIQUID WASTE MANAGEMENT.....	27
6.2.2	SOLID WASTE MANAGEMENT.....	27
8.0	POTENTIAL IMPACTS.....	29
8.1	MOBILIZATION PHASE	29
8.1.1	POSITIVE IMPACTS	29
8.1.1.1	<i>Employment opportunities</i>	29
8.1.2	NEGATIVE IMPACTS.....	30
8.1.2.1	<i>Noise pollution</i>	30
8.1.2.2	<i>Air Pollution from dust emission</i>	30
8.2	CONSTRUCTION PHASE	30
8.2.1	POSITIVE IMPACTS.....	30
8.2.1.1	<i>Employment opportunities</i>	30
8.2.1.2	<i>Improved living conditions and economic growth</i>	31
8.2.1.3	<i>Improved public health</i>	31
8.2.1.4	<i>Increased socio-cultural interaction</i>	31
8.2.1.5	<i>Increased Revenue to the nation through taxes, both direct and indirect</i> 31	
8.2.2	NEGATIVE IMPACTS.....	32
8.2.2.1	<i>Increased HIV/AIDS and other sexual related diseases:</i>	32
8.2.2.2	<i>Destruction and infringement of properties</i>	32
8.2.2.3	<i>Noise pollution</i>	33
8.2.2.4	<i>Air Pollution from dust emission</i>	33
8.2.2.5	<i>Potential communicable diseases transmission</i>	34
8.2.2.6	<i>Smells and flies in toilets</i>	34
8.2.2.7	<i>High Risk of Health associated with construction work</i>	34
8.3	OPERATION PHASE.....	36
8.3.1	POSITIVE IMPACTS.....	36
8.3.1.1	<i>Improved social-economic livelihood and dignity within the beneficiary society</i>	36
8.3.1.2	<i>Increased Revenue to the nation through taxes, both direct and indirect</i>	36
8.3.2	NEGATIVE IMPACTS	36
8.3.2.1	<i>Smells and flies in toilets</i>	36
9.0	ACTION PLAN FOR PREVENTION AND MANAGEMENT OF ACCIDENTS DURING IMPLEMENTATION STAGE.....	37
9.1	OCCUPATIONAL HEALTH AND SAFETY	37

9.1.1	EMERGENCY PREPAREDNESS PLAN	38
9.2	SECURITY	38
9.3	MONITORING, MAINTENANCE AND REPAIR	38
10.0	ENVIRONMENTAL AND SOCIAL MANAGEMENT PLAN.....	39
10.1	ENVIRONMENTAL AND SOCIAL MANAGEMENT PLAN.....	39
11.0	MONITORING PLAN	46
11.1	ENVIRONMENTAL MONITORING.....	46
12.0	PROJECT BUDGET	50
13.0	STAKEHOLDER VIEWS ON THE PROPOSED PROJECT.....	50
	APPENDIX I: LIST OF STAKEHOLDERS CONSULTED	52
	APPENDIX II: MINUTES OF LOCAL COMMUNITY CONSULTATIONS.....	54
	APPENDIX III: PERMIT TO USE THE OPEN SPACE FOR CONSTRUCTION OF PUBLIC TOILET.....	59
	APPENDIX IV: MEMORANDUM OF UNDERSTANDING BETWEEN DAWASA AND DAR ES SALAAM MUNICIPAL COUNCILS.....	61
	APPENDIX V: ARCHITECTURAL DRAWINGS.....	62
	APPENDIX VI: NON-TECHNICAL SUMMARY.....	63
	APPENDIX VII: SCREENING LETTER FROM NEMC	71

LIST OF FIGURES

Figure 1: A Map of Dar es salaam region showing the project Municipal.....4

Figure 2: An Extract Google view to show the Location of the project area5

Figure 3: Vegetation and business the structures at the project site.....6

Figure 4: Power lines, Bus stop and business structures around the project site6

Figure 5: Floor Plan for Public Toilet.....24

Figure 6: Stakeholder’s consultation meeting with Magomeni Garden Sofa Makers..... 50

LIST OF TABLES

Table 1: The coordinates of the project area3

Table 2: The Proposed standard Public Toilet working spaces with their
respective areas..... 23

Table 3: Quantities of construction Materials 25

Table 4: Management of construction and operation wastes28

Table 5: Environmental and Social Management Plan for the Proposed
Construction of Public Toilet at Magomeni Garden, Magomeni ward,
Kinondoni Municipality 41

Table 6: Monitoring Plan for the Proposed Construction of Public Toilet at
Magomeni Garden, Magomeni Ward, Kinondoni Municipality 47

Table 6: Issues and concerns rose by stakeholders 51

EXECUTIVE SUMMARY

Comprehensive Project Brief for the Proposed Public Toilet to be built at Magomeni Garden, Magomeni Ward, Kinondoni Municipality

Proponent: Dar es Salaam Water Supply & Sanitation Authority

Proponent's Contact: DAWASA,
DAWASA Building, Dunga/Malaga Street,
Mwananyamala Area
P. O. Box 1573, Dar es Salaam. TANZANIA.
Tel. +25522276006/15; Fax: +255222762480;
E-mail: dawasaceo@dawasa.co.tz

EIA Expert: Prof. Rubhera RAM Mato (PhD), CEng. (T), Reg. EIA Expert
P. O BOX 35478, Dar es Salaam, Tanzania
Mobile: +255754898592
E-Mail: rubheramato@gmail.com

INTRODUCTION

The Government of the United Republic of Tanzania (GoT) through the Dar es Salaam Water and Sewerage Authority (DAWASA) under the Ministry of Water intends to implement an Off Grid Sanitation Project (OGSP) in Dar es Salaam City to serve peri-urban areas not connected to the central sewerage system. DAWASA has received financing from the International Development Association (IDA) in the form of a credit to implement the project. Prior to implementing the project, the law in Tanzania requires an Environmental Impact Assessment to be conducted and approved by relevant authority. In order to comply with the law in Tanzania, the DAWASA intends to apply a portion of the proceeds of the credit to eligible payments for consulting services for Preparation of Environmental and Social Impact Assessment (ESIA) and Resettlement Action Plan (RAP) Report for construction of off grid sanitation projects.

Dar es Salaam is the largest and most important commercial and industrial centre in Tanzania. According to the Tanzania National Census of August 2022, the city has an estimated population of about 5,383,728 people, (sense.nbs.go.tz, accessed December 24, 2022). About 10% of the population is served by sewers and the rest almost depend on on-site sanitation systems. The sewer coverage is only limited to the area within city centre with a total length of 67.8 km and the system is based on a separate systems and discharge their effluent into oxidation ponds, and into the sea through sea outfall of about 1.03 km long. The onsite sanitation systems result into faecal sludge of which handling and management throughout the sanitation chain (from domestic containment, transportation as well as disposal and treatment) is currently hygienically inadequate thus posing environmental and public health risks. The Off Grid project is intended to address these challenges. The Off Grid project is divided into several subprojects which will be implemented in the five municipalities of Dar es Salaam City. One of these is the Construction of a Public Toilet at Magomeni Garden, Magomeni Ward, and Kinondoni Municipality. The toilet will mostly serve the people who are doing their business close to the proposed site (Mamantilie and their customers), bodaboda and passersby.

The ESIA study was conducted in accordance with the Environmental Management (Environmental Impact Assessment and Audit) (Amendment) Regulations, 2018 along with the Environmental Impact Assessment and Audit Regulations of 2005. These Regulations provide legal procedures for implementing the requirements of the Environmental Management Act Cap.191 of 2004. The Regulations give mandate to NEMC to oversee the EIA process, which culminates with an award of the EIA Certificate by the Ministry responsible for Environment.

In accordance with the EIA Regulations, NEMC is mandated to screen projects and make decisions of level of EIA required as well as evaluating the adequacy of respective environmental statements. Considering the nature and size of the proposed “Public Toilet Project in Kinondoni Municipality”, the

project falls under Category “B2” (Non-Mandatory) in accordance with Reg.4 (1) (c) and First Schedule of the amended 2018 Regulations which categorizes the *night soil collection and treatment* being under the ‘*List of small-scale activities and enterprises that require registration but shall not require Environmental Impact Assessment. Further, the projects shall not require screening and scoping, rather, the Project Brief shall be examined and issued with an Environmental Impact Assessment Certificate*’.

The regulations require developers to prepare and submit to the National Management Council (NEMC) filled EIA registration forms and “Project Briefs” for all B2 projects. The preparation and content of the “Project Briefs” is provided under Reg.6 (1). The same has been followed in preparing this “Project Brief”. The project brief was conducted in July-August 2020.

This project brief for the Proposed Construction of Public Toilet in Kinondoni Municipality is being submitted to NEMC together with EIA Registration Forms for EIA Certificate decision.

POLICY, LEGAL AND INSTITUTIONAL FRAMEWORK

Tanzania is committed to attaining sustainable development goals. This urge is envisaged in the National Environmental Policy and other sectoral policies including;

- National Environment Policy, 2021
- National Land Policy of 2021
- Construction Industry Policy (2003)
- National Health Policy (2003)
- National Gender Policy of 2000
- National Human Settlements Development Policy (2000)

Important laws and regulations that have relevance to road development in respect of environmental management include;

- Environmental Management Act (2004)
-

- The Environmental Management (Fees and Charges) Regulations, 2021
- The Environmental Management (Control of hazardous Waste) regulations, 2021
- The Environmental Management (Control of Noise and vibration) regulations, 2015
- The Environmental Management (Prohibition of Plastic Carrier bags) regulations, 2019
- The Environmental Management (Solid Waste Management) regulations, 2007
- The Environmental Management (Water Quality) regulations, 2009
- The Environmental Management (Air Quality) regulations, 2009
- The Environmental Management (Soil Quality) regulations, 2009
- Occupational Health and Safety Act 2003
- The Water Supply and Sanitation Act No. 12 of 2009
- Engineers Registration Act and its Amendments 1997 and 2007
- The Contractors Registration (Amendment) Act, 2008
- The Architects and Quantity Surveyors Act (1997)
- The Urban Planning Act (2007)
- Public Health Act (2009)
- World Bank guidelines for Environmental Management

PROJECT DESCRIPTION

The main land use at the proposed project site includes; power lines, Kawawa road, BRT Bus stop, bodaboda parking, Church, small business structures, Sofa making Workshop and carpentry, open space which is used for recreation and New Garden Breeze Bar.

.The major construction activities for the sub-projects include;

- **Site Clearance:** The contractor shall clear the construction areas within the site of all boulders, natural obstructions, rubbish and any other natural or artificial obstructions, which would interfere with construction of buildings, roads, paths and drains.

- Excavation: Excavations for foundations and the reinforced concrete structure shall be to the widths, depth and levels to accommodate the structure shown on the drawings. Working space has been allowed for in the measurement of excavation quantities given in these Bills of Quantities in accordance with the rules of measurement laid down elsewhere in these Bills, namely 1.00 meter from the face of any work which requires formwork over 1m deep below the starting level of excavation, and 0.30 meter from face of any work which requires formwork not exceeding 1-metre-deep below starting level of excavation.
- Filling: The fill shall be clean, selected coarse sand or gravel. It should be taken from borrow pits if the soil on the site is found to contain too much fines and to have too low plasticity limit to be used as fill.
- Soil Sterilization: Anti-termite treatment is to be carried out by an approved specialist firm who will be required, upon completion of the soil sterilization, to furnish a written qualifying guarantee which includes; the chemicals applied comply with the requirements and concentration, the treatment will remain effective against termite infestation for a period of five years as well as free re-treatment by the firm of any areas showing signs of infestation before the expiry of the five-year period.
- Disposal of surplus excavated material: Surplus excavated material will be carted away from the vicinity of the walls and deposited, spread and levelled on areas to be allocated by the Structural Engineer, reasonably adjacent to the site.
- Concrete work
- Steel fixing and Formwork preparation

PROJECT ENVIRONMENT

Project site

The project site is located at Magomeni ward, Kinondoni Municipal within Dar es Salaam Region. The project site is geographically located at 37S UTM

zone. The site is 4.4 Kilometers from Dar es Salaam city centre via Morogoro road.

Magomeni ward in Kinondoni Municipality of Dar es Salaam Region in which the proposed site is located is close to the warm Indian Ocean. Thus, the area experiences a tropical wet and dry climate with hot and humid weather throughout the year. Generally, site area has two distinct rainy seasons, 'long' rains during April and May, and 'short' rains during October and November with a mean annual rainfall of between 800–1200mm. The average annual daily temperatures range between 21.9°C and 29.6°C. The climate is also influenced by the south-westerly monsoon winds from April to October and north-westerly monsoon winds between November and March (TMA, 2011). Implementation of Public toilet project will not affect the climate in Magomeni Garden area.

Water Table and water quality analysis

Groundwater is abundant in almost the entire Dar es salaam City. This is evidenced by the fact that shallow wells are one of the sources of domestic water supply for most of the households around the project site and therefore the water table is high.

Data for Water quality from shallow wells close to the project site were not immediately available during this study. However previous studies of the similar areas indicate the high possibility of groundwater contamination from adjacent pit latrines located less than 30m horizontal distance from the shallow well (Still and Nash, 2002).

Air quality

The air quality observations indicate that the general air quality in the project area is good as there is no any strange activity contributing to air pollution. However, seasonal variation as well as localized and temporal deterioration in air quality does occur. Smokes and greenhouse gases such as carbon dioxide, carbon monoxide are expected to be emitted from moving vehicles due to the burning of fossil fuels which passes at Magomeni road which and

other street roads closer to the project area. During construction phase, air quality of the area will be impacted and the proponent will be advised to use good quality material transportation vehicles.

Noise levels

The noise level at the project area is mainly due to moving vehicle along the road, moving air (wind) or rain and birds. Project activities during construction will change patterns and amplitude of noise in the project area. Operations of construction machines may cause adverse impacts on local residents, and on workers. The proponent has to ensure proper provision of ear mask to the workers and all works have to be executing during the day time.

Climate

Magomeni ward in Kinondoni Municipality of Dar es Salaam Region in which the proposed site is located is close to the warm Indian Ocean. Thus, the area experiences a tropical wet and dry climate with hot and humid weather throughout the year. Generally, site area has two distinct rainy seasons, 'long' rains during April and May, and 'short' rains during October and November with a mean annual rainfall of between 800–1200mm. The average annual daily temperatures range between 21.9°C and 29.6°C. The climate is also influenced by the south-westerly monsoon winds from April to October and north-westerly monsoon winds between November and March (TMA, 2011). Implementation of Public toilet project will not affect the climate in Magomeni area

Vegetation

The proposed project site is characterized with no immediate vegetation at the vicinity of the project site.

PROJECT STAKEHOLDERS AND INVOLVEMENT

A simple methodology was adopted to identify key stakeholders and main environmental and social concerns. This involved physical observations and

consultations (direct consultations). Other information on the project was obtained through a desk study.

During the conduction of this study, different stakeholders were consulted. Among these include the Kinondoni Municipal Council and community at Magomeni area. During the meeting, the consultant gave a brief explanation on the proposed public toilet.

POTENTIAL SIGNIFICANT ENVIRONMENTAL AND SOCIAL IMPACTS

The impacts are categorized into Mobilization phase impacts, Construction phase impacts, and Operational phase impacts. The main receptors of impacts associated with the anticipated Construction of a Public Toilet at Magomeni Garden, Magomeni ward, Kinondoni Municipality include physical resources (groundwater quality, soils, air quality, and noise); ecological resources (vegetation); material assets, public health, and safety, aesthetics, and landscape.

The following impacts were identified to be likely to occur during Mobilization Phase

- Employment opportunities
- Noise pollution
- Air Pollution from dust emission

The following impacts were identified to be likely to occur during Construction Phase

- Employment opportunities
 - Improved living conditions and economic growth
 - Improved public health
 - Increased socio-cultural interaction
 - Increased Revenue to the nation through taxes, both direct and indirect
 - Increased HIV/AIDS and other sexual related diseases:
 - Destruction and infringement of properties
 - Noise pollution
 - Air Pollution from dust emission
-

- Potential communicable diseases transmission
- Smells and flies in toilets
- High Risk of Health associated with construction work
- Waste generation during construction
- Groundwater contamination from soil sterilization

The following impacts were identified to be likely to occur during Operation Phase

- Improved social-economic livelihood and dignity within the beneficiary society
- Increased Revenue to the nation through taxes, both direct and indirect
- Smells and flies in toilets

PREVENTION AND MANAGEMENT OF ACCIDENTS DURING IMPLEMENTATION STAGE

The project shall be implemented in compliance to labour laws in Tanzania, in particular, the Occupational Health and Safety Act (2003). Clauses to protect the health and safety of workers shall be included in the contract documents for implementation stage which includes the following; provision and enforcement of the use of appropriate personal protective equipment for all workers e.g. overalls, gloves, masks, etc. (wherever required), presence of the emergency preparedness plan in place prior to commencement of construction activities as well as ensuring security matter of the site by fencing the whole project area and provide gates for entrance and exit purpose.

MITIGATION MEASURES AND ENVIRONMENTAL AND SOCIAL MANAGEMENT PLAN (ESMP)

The options to minimize or prevent the identified adverse social and environmental impacts as well as a monitoring plan have been suggested in this report and are contained in the ESMP. Many of them are based on good engineering practices and the timely responsiveness of the responsible institution. The ESMP describes the implementation schedule of the proposed mitigation measures as well as planning for long-term monitoring activities. It

defines the roles and responsibilities of different actors of the plan. The Approach environmental and social costs amount to TSH 38,000,000 (Excluding the costs that will appear in then (BOQ) and resettlement exercise. The estimated annual costs for carrying out the proposed environmental and social motoring program amounts to TSH 24,000,000.

CONCLUSION

The proposed Public Toilet project in Magomeni Ward, Kinondoni Municipality, Dar es Salaam, is regarded as a small project. The project benefits includes in the principle to improve and promote public health through proper waste management (in particular improved sanitation). When there is a good and improved sanitation, then the outbreak of diseases lie waterborne are reduced and prevented hence achieving improved public health. The facility shall also generate income to the municipality. Moreover, the proposed location of the public toilet is not in environmentally sensitive area.

The anticipated impacts identified are of small dimension and of less negativity to the community and the environment. All impacts can be mitigated.

Comprehensive Project Brief for the Proposed Public Toilet to be built at Magomeni Garden, Magomeni Ward, Kinondoni Municipality

1.0 BACKGROUND AND JUSTIFICATION

The Government of the United Republic of Tanzania (GoT) through the Dar es Salaam Water and Sewerage Authority (DAWASA) under the Ministry of Water intends to implement an Off Grid Sanitation Project (OGSP) in Dar es Salaam City to serve peri-urban areas not connected to the central sewerage system. DAWASA has received financing from the International Development Association (IDA) in the form of a credit to implement the project. Prior to implementing the project, the law in Tanzania requires an Environmental Impact Assessment to be conducted and approved by relevant authority. In order to comply with the law in Tanzania, the DAWASA intends to apply a portion of the proceeds of the credit to eligible payments for consulting services for Preparation of Environmental and Social Impact Assessment (ESIA) and Resettlement Action Plan (RAP) Report for construction of off grid sanitation projects.

Dar es Salaam is the largest and most important commercial and industrial centre in Tanzania. According to the Tanzania National Census of August 2022, the city has an estimated population of about 5,383,728 people, (sense.nbs.go.tz, accessed December 24, 2022). About 10% of the population is served by sewers and the rest almost depend on on-site sanitation systems. The sewer coverage is only limited to the area within city centre with a total length of 67.8km and the system is based on a separate systems and discharge their effluent into oxidation ponds, and into the sea through sea outfall of about 1.03km long. The onsite sanitation systems result into Faecal sludge of which handling and management throughout the sanitation chain (from domestic containment, transportation as well as disposal and treatment) is currently hygienically inadequate thus posing environmental and public health risks. The Off Grid project is intended to address these challenges. The Off Grid project is divided into several subprojects which will be implemented in the five municipalities of Dar es

Salaam City. One of these is the Construction of a Public Toilet at Magomeni Garden, Magomeni ward in Kinondoni Municipality. The toilet will mostly serve the people who are doing their business close to the proposed site (*Mamantilie* and their customers), bodaboda and passersby.

The ESIA study was conducted in accordance with the Environmental Management (Environmental Impact Assessment and Audit) (Amendment) Regulations, 2018 along with the Environmental Impact Assessment and Audit Regulations of 2005. These Regulations provide legal procedures for implementing the requirements of the Environmental Management Act Cap.191 of 2004. The Regulations give mandate to NEMC to oversee the EIA process, which culminates with an award of the EIA Certificate by the Ministry responsible for Environment.

In accordance with the EIA Regulations, NEMC is mandated to screen projects and make decisions of level of EIA required as well as evaluating the adequacy of respective environmental statements. Considering the nature and size of the proposed “Public Toilet Project in Kinondoni Municipality”, the project falls under Category “B2” (Non-Mandatory) in accordance with Reg.4 (1) (c) and First Schedule of the amended 2018 Regulations which categorizes the *night soil collection and treatment* being under the ‘*List of small-scale activities and enterprises that require registration but shall not require Environmental Impact Assessment. Further, the projects shall not require screening and scoping, rather, the Project Brief shall be examined and issued with an Environmental Impact Assessment Certificate*’

The regulations require developers to prepare and submit to the National Management Council (NEMC) filled EIA registration forms and “Project Briefs” for all B2 projects. The preparation and content of the “Project Briefs” is provided under Reg.6 (1). The same has been followed in preparing this “Project Brief”. The project brief was conducted in July-August 2020.

This project brief for the Proposed Construction of Public Toilet in Kinondoni Municipality is being submitted to NEMC together with EIA Registration Forms for EIA Certificate decision.

2.0 NATURE OF THE PROJECT

The proposed project concerns construction of an engineered sanitary depository for sewage (night soil) for public use at Magomeni Garden, Magomeni ward, Kinondoni Municipality. The nature of the project enhances environmental protection through proper handling and disposal of domestic sewage. According to First Schedule of the EIA and Audit Regulations (Amended) of 2018, the nature of the project is small and entails no significant impacts. The project can be categorised as Type B2, which according to the regulations are “small-scale activities and enterprises that require registration but shall not require Environmental Impact Assessment. Further, the projects shall not require screening and scoping, rather, the Project Brief shall be examined and issued with an Environmental Impact Assessment Certificate”.

3.0 PROJECT DESCRIPTION

3.1 Project Location

The project site is located at Idrissa Mtaa, Magomeni ward, Kinondoni Municipal within Dar es Salaam Region. The project site is geographically located at 37S UTM zone with coordinates in Table 1. The site is 4.4 Kilometers from Dar es Salaam city centre via Morogoro road. (Refer Figure 1, and Figure 2).

Table 1: The coordinates of the project area

S/N	Coordinates	
	Easting	Northing
1	528659.87	9247794.207

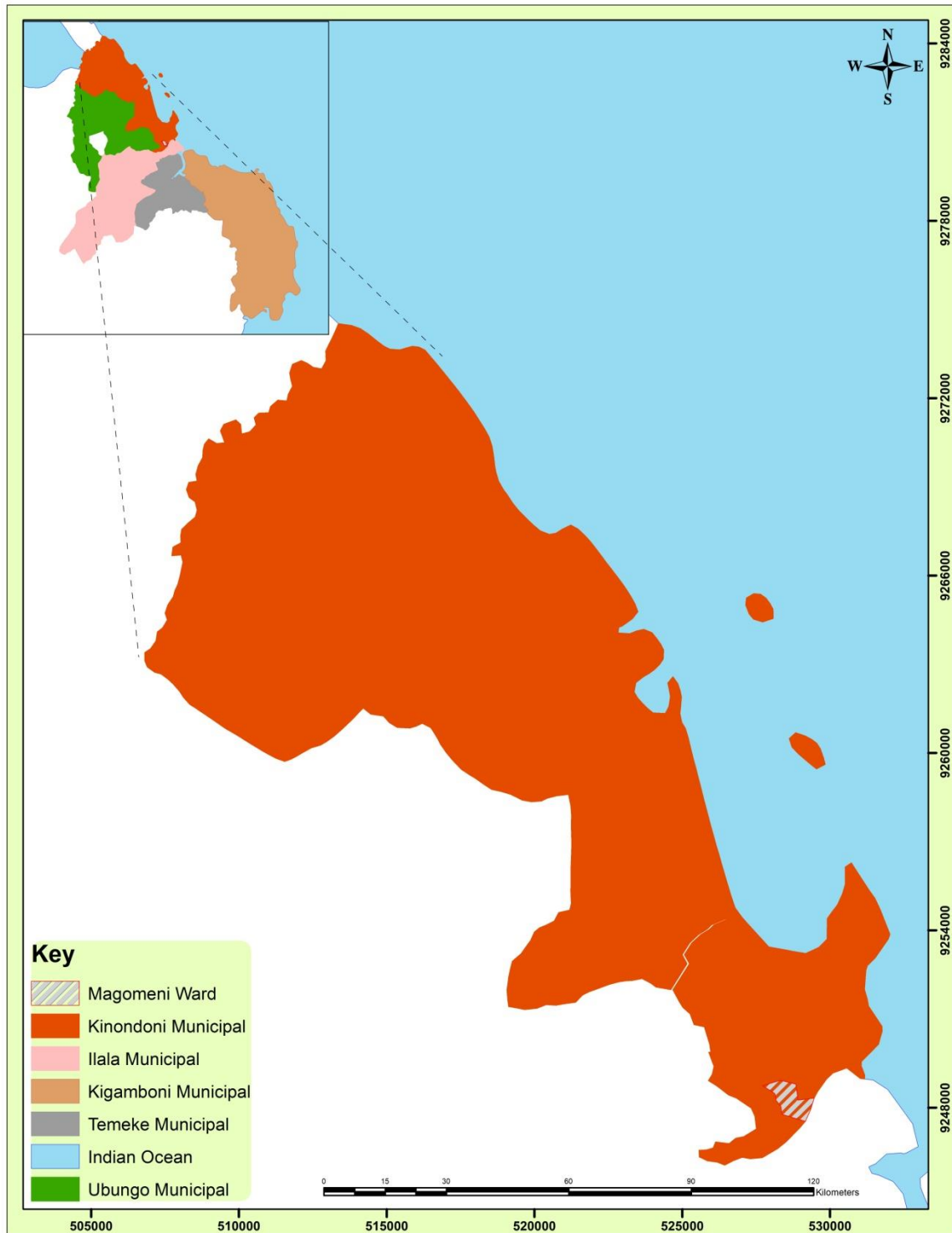

Figure 1: A Map of Dar es salaam region showing the project Municipal



Figure 2: An Extract Google view to show the Location of the project area

3.2 Accessibility

The project area is accessible through Morogoro road. The project site is less than 5 meters from Kawawa road and is located at the left side as one move from Morocco to Magomeni via Kawawa road. The project site is located close Magomeni Hospital Bus stop. Otherwise the site is accessible from all directions and there is no any physical restriction.

3.3 Specific Features

There are both natural and artificial vegetation within and adjacent to the proposed project site especially shade tree (*Acrocarpus nfraxinifolius*), Also there are commercial structures including Sofa Workshop and Magomeni garden itself few meters from proposed project site (Figure 3).



Figure 3: Vegetation and business the structures at the project site

3.4 Adjacent Land Use

The main land use at the proposed project site includes; power lines, Kawawa road, BRT Bus stop, bodaboda parking, Church, small business structures, Sofa making Workshop and carpentry, open space which is used for recreation and New Garden Breeze Bar, figure 4.



Figure 4: Power lines, Bus stop and business structures around the project site

3.4.1 Land Ownership

The proposed Magomeni Garden Public toilet project site is solely owned by Kinondoni Municipal Council. The municipality has apportioned about 400m² piece of land for public toilet construction. There is a Memorandum of Understanding (MoU) that has been signed between DAWASA and Kinondoni Municipal Council for the implementation of the project (Appendix II). In this MoU, DAWASA is responsible for the construction of the toilet while the Kinondoni Municipality avails land running the project.

3.5 Baseline information

3.5.1 Water Table and water quality analysis

Groundwater is abundant in almost the entire Dar es salaam City. This is evidenced by the fact that shallow wells are one of the sources of domestic water supply for most of the households around the project site and therefore the water table is high.

Data for Water quality from shallow wells close to the project site were not immediately available during this study. However previous studies of the similar areas indicate the high possibility of groundwater contamination from adjacent pit latrines located less than 30m horizontal distance from the shallow well (Still and Nash, 2002).

3.5.2 Air quality

The air quality observations indicate that the general air quality in the project area is good as there is no any strange activity contributing to air pollution. However, seasonal variation as well as localized and temporal deterioration in air quality does occur. Smokes and greenhouse gases such as carbon dioxide, carbon monoxide are expected to be emitted from moving vehicles due to the burning of fossil fuels which passes at Magomeni road which and other street roads closer to the project area. During construction phase, air quality of the area will be impacted and the proponent will be advised to use good quality material transportation vehicles.

3.5.3 Noise levels

The noise level at the project area is mainly due to moving vehicle along the road, moving air (wind) or rain and birds. Project activities during construction will change patterns and amplitude of noise in the project area. Operations of construction machines may cause adverse impacts on local residents, and on workers. The proponent have to ensure proper provision of ear mask to the workers and all works have to be executing during the day time.

3.5.4 Climate

Magomeni ward in Kinondoni Municipality of Dar es Salaam Region in which the proposed site is located is close to the warm Indian Ocean. Thus, the area experiences a tropical wet and dry climate with hot and humid weather throughout the year. Generally, site area has two distinct rainy seasons, 'long' rains during April and May, and 'short' rains during October and November with a mean annual rainfall of between 800–1200mm. The average annual daily temperatures range between 21.9°C and 29.6°C. The climate is also influenced by the south-westerly monsoon winds from April to October and north-westerly monsoon winds between November and March (TMA, 2011). Implementation of Public toilet project will not affect the climate in Magomeni area.

4.0 POLICIES, LEGISLATION AND INSTITUTIONAL ASPECT

According to the fundamental principles of environment, any developmental activities of this nature such as construction of Public Toilet would have socio-economic and somehow environmental impacts that must be addressed and governed in order to serve public interest and sustainable development. Given the many existing and developing environmental laws, regulations and standards in Tanzania, it is worth considering resorting to constitutional provisions to protect and manage the environment. With increasing environmental awareness in recent decades, the environment has become a higher political priority and many constitutions now expressly guarantee a 'right to a healthy environment', as well as the procedural rights necessary to implement and enforce the substantive rights granted. The public or national interest in this aspect is addressed through government Policies and regulated by Principal Acts and Regulations. The implementation of the proposed project shall touch various sectors; therefore, the developer has to comply with number of cross-sectorial policies and legislations relevant to this project. Also, the listed institutions involved in environmental management for the project is included in this chapter.

4.1 RELEVANT POLICIES

This section focuses on various policies which guide the development aspects for sustainable vision, apart from the national environmental policy, there are numbers of sector policies that are to be reviewed when executing the proposed development and these include;

4.1.1 National Environment Policy 2021

This is the main policy document governing environmental management in the country. The NEP defines environmental issues as both natural and social concerns and adopts the key principle of sustainable development. The NEP has also proposed the framework environmental legislation to be taken into account by the numerous agencies of the Government involved in regulating the various sectors. The NEP defines strategic plans for environmental management at all levels and provides an approach for mainstreaming environmental issues for decision-making particularly the use of Environmental Impact Assessment. During implementing the project, Contracting Authority should consider the requirements of the policy including environmental protection through implementing impacts mitigation, management and monitoring plans. Henceforth the preparation of this Improved Project Brief study aims at adhering to this policy through identifying impacts, proposing mitigation, management and monitoring plans.

4.1.2 National Land Policy of 1997

The National Land Policy states that “the overall aim of a National Land Policy is to promote and ensure a secure land tenure system, to encourage the optimal use of land resources, and to facilitate broad-based social and economic development without upsetting or endangering the ecological balance of the environment”. This study partly responds to this requirement.

4.1.3 Construction Industry Policy (2003)

Among the major objectives of the policy, which supports a sustainable building development sector, include the promotion and application of cost effective and innovative technologies and practices to support socio-economic development activities such as sanitation, water supply, buildings, road-works,

shelter delivery and income generating activities and to ensure application of practices, technologies and products which are not harmful to either the environment or human health. Proposed project is in-line with this policy as ultra-modern technology is used during construction and its operation.

4.1.4 National Health Policy (2003)

The Health Policy is a vital guide towards health development of any country. It is particularly, important in a country like ours where resources and technology are more limited than in other countries, which are relatively better off in both technology and resources. This Policy is a revision of the 1990 Health Policy, which emphasized on the need for increasing community involvement in health development and improved access and equity in health and health services.

The Policy recognizes the challenges of consolidating the principles of the previous health policy in community involvement, improved health services provision, access and equity while addressing the different dimensions of reforms that are taking place in the Public Sector.

The proposed project will adhere to policy requirements to ensure no transmission of such communicable diseases between construction workers and the community protects workers from all sorts of health risks and hazards; and provide adequate sanitation services within the project and ensure that its activities are not a source of health issues.

4.1.5 National Gender Policy of 2000

The overall objective of the Gender and Development Policy is to promote gender equality and equal participation of men and women through facilitation of access to education, child care, and employment and decision making. Also this policy is to provide guidelines that will ensure that gender-sensitive plans and strategies are developed in all sectors and institutions. While the policy aims at establishing strategies to eradicate poverty, it emphasizes gender quality and equal opportunity of both men and women to participate in development undertakings and to value the role played by each member of

society. The proposed project will implement the requirements addressed under this policy.

4.1.6 National Human Settlements Development Policy (2000)

Among the objectives of this policy is to improve the level of the provision of infrastructure and social services for the development of sustainable human settlements and to make serviced land available for shelter to all sections of the community. Such infrastructure and services constitute the backbone of urban/rural economic activities. Public Toilet is one among of the important infrastructure for Magomeni Garden, Magomeni ward community and country at large.

4.2 PRINCIPAL LEGISLATIONS AND REGULATIONS

The ESIA team reviewed several legislations relevant to the construction of Public toilets. These encompass Principal Acts that support and provide guidelines to implement the intended project as discussed below.

4.2.1 Environmental Management Act (2004)

Among the major purposes of the EMA are to provide the legal and institutional framework for sustainable management of the environment in Tanzania; to outline principles for management, impact and risk assessment, the prevention and control of pollution, waste management, environmental quality standards, public participation, compliance, and enforcement; to provide the basis for the implementation of international instruments on the environment; to provide for the implementation of the National Environmental Policy; to provide for the establishment of the National Environmental Fund and to provide for other related matters.

Part III, Section 15(a) states that *"in matters about the environment, the Director of Environment shall coordinate various environment management activities being undertaken by other agencies to promote the integration of environmental considerations into development policies, plans, programs, strategies projects and undertake strategic environmental assessments to*

ensure the proper management and rational utilization of environmental resources on a sustainable basis for the improvement of the quality of human life in Tanzania".

Part X of the law deals with Environmental Quality Standards. Section 140 of this act states that *"The National Environmental Standards Committee of the Tanzania Bureau of Standards established under the Tanzania Bureau of Standards Act, 1975 shall develop, review and submit to the Minister proposal for environmental standards and criteria concerning; water quality; discharge of effluent into the water; air quality; control of noise and vibration pollution; sub-sonic vibrations; soil quality, control of noxious smells; light pollution; and any other environmental quality standard"* Some of these standards have already been published in the government *gazette* while others are not in place. This project shall consider all the standards specified by this act.

4.2.2 The Environmental Management (Fees and Charges) Regulations, 2021

These Regulations shall apply in relation to an act or service in respect of which fees and charges are payable under the Act and Regulations made thereunder. The regulations emphasize that "a person shall not, upon payment of fees and charges prescribed in the Schedule to these Regulations, carry on any of the following":

- Environmental Impact Assessment;
- Environmental Compliance Monitoring and Audit;
- Registration of Environmental Experts;
- Environmental Quality Standards;
- Noise and Vibrations; or
- other activities related to the environment

This project complies with the regulations since the proponent has already paid registration fees and review charges as directed by NEMC.

4.2.3 The Environmental Management (Control of hazardous Waste) regulations, 2021

The objective of these regulations is to protect the environment and human health by preventing or reducing the generation of Hazardous waste, the adverse impacts of the generation and management of hazardous waste and by reducing overall impacts of resource use and improving the efficiency of such use, which are crucial for the transition to a circular economy. The regulation requires that “any person generating, collecting, storing, transporting, treating, recycling, reusing, recovering and disposing of hazardous waste or any person exercising jurisdiction under these Regulations shall, assure that there are no adverse impacts to be generated or caused by the activity conducted. Project developer will comply with the requirements of this regulation by reducing the construction materials which may generate hazardous impacts, as well as proper handling of such waste such as in use of fuels for various purposes etc.

4.2.4 The Environmental Management (Control of Noise and vibration) regulations, 2015

The regulations focus on the maintenance of a healthy environment for all the people in Mainland Tanzania, the tranquility of their surrounding and their psychological well-being by regulating noise and vibration levels to prescribe the maximum permissible noise and vibration levels from a facility or activity to which a person may be exposed. The project developer will make sure that all the guidelines under this policy will be considered to ensure the healthy environment to everyone.

4.2.5 The Environmental Management (Prohibition of Plastic Carrier bags) regulations, 2019

Regulations are meant to impose a total ban on the import, export, manufacturing, sale, and use of plastic carrier bags regardless of their thickness. Plastic carrier bags has a wide definition in the Regulations, as a bag made of plastic film, with or without handles, or gussets and to which its layer is in any thickness. The Regulations also categorically state that no

person shall sell or offer for sale beverages or other commodities wrapped in plastics unless the nature of such commodities require wrappings by plastics, and restricts any licensing authority from issuing any licenses after the Regulations come into force. Project developer will make sure that there will be no use of plastic bags within the project site and the whole project life time, also in case of the need of carrier bags the proponent will make sure that there will be alternative bags which are allowed by the regulations. For the commodities that are wrapped in plastic, then the proponent will make sure that such plastic will be handled properly.

4.2.6 The Environmental Management (Solid Waste Management) regulations, 2007

The solid waste management regulation of 2007 provides general directive on management of solid waste as follows: -

Regulation details the requirements and responsibilities for managing solid waste in Tanzania.

Highlight waste minimization and cleaner production principles alongside the duty to safeguard the public health and the environment from adverse effects of solid waste. The detail permitting requirements notably that any person dealing with solid waste as collector, transporter, waste depositor or manager of a transfer station will apply to the LGA for a permit. The local authority will also issue licenses to individuals or companies qualified to operate solid waste disposal sites; permit is required to operate an LGA waste disposal site. The proposed project is expected to generate solid waste in construction phase. Therefore, to comply with this regulation the Project developer will engage the registered solid waste collection contractor.

4.2.7 The Environmental Management (Water Quality) regulations, 2009

Regulations provide for institutional and legal framework for sustainable management and development of water resources; to outline principles for water resources management; to provide for the prevention and control of water pollution; to provide for participation of stakeholders and the general public in implementation of the National Water Policy. These regulations

require the sustainable management of water sources and proper use of the available sources without causing any damage towards such sources. Also, the regulations emphasize that it is every one's responsibility to conserve and preserve the available water sources in Tanzania. During all phases of the project there will be water demand, hence the project developer will make sure that there will be a sustainable use of water. Also during construction and maintenance phase the developer will make sure that the water supply pipes will not be damaged in either ways.

4.2.8 The Environmental Management (Air Quality) regulations, 2009

The Regulations were formed in order to: -

- Prohibit emissions and releases of hazardous substances into the environment
- Prescribe permissible emission limits and quantities of emissions of sulphur oxide, carbon monoxide, black smoke and suspended particulate matters, nitrogen oxide, ozone, hydrocarbons, dust and lead
- Empower NEMC to issue air pollutant emission permits, enforce compliance, undertake emergency prevention and issue stop orders
- Set baseline parameters on air quality and emissions based on a number of practical considerations and acceptable limits and ensure protection of human health and the environment from various sources of pollution.

The proposed project will implement the requirements of this Act, emission limits will be monitored to the permissible limits.

4.2.9 The Environmental Management (Soil Quality) regulations, 2009

These Regulations made by the Minister of State under sections 143, 144 and 230 of the Environmental Management Act, concern soil pollution and soil quality standards and provide with respect to a soil protection permit and compliance system. They also concern measures of enforcement. The object of these Regulations is to

- Set limits for soil contaminants in agriculture and habitat;

- Enforce minimum soil quality standards prescribed by the National Environmental Standards Committee.

Also, the regulations require that, the contaminants of volatile organic compounds in habitat and agricultural soils shall comply with parameters and upper limits as prescribed and contaminants of heavy metals in habitat; agricultural soils shall comply with parameters and upper limits as prescribed and contaminants of pesticides in habitat and agricultural soils shall comply with parameters and upper limits as prescribed. Local government authority may prescribe special or specific measures and guidelines for soil conservation applicable to their respective areas of jurisdictions which are not below standards prescribed under these Regulations. The Project developer will comply with the requirements made under these regulations.

4.2.10 Occupational Health and Safety Act 2003

The provisions of this law require employers to provide decent working environment to employees to guarantee their health and safety. Occupational health and safety services are important for sustainable development of a country, as they reduce occupational accidents and diseases which can have huge economic burden to individuals, enterprises and the nation as whole. Improving health and safety of workers will significantly increase productivity at the workplaces to encourage more investments, increase job creation, higher morale, and job satisfaction hence industrial harmony. The law also entails employers to fulfill obligations of ensuring safety of the equipment's used by workers and providing proper safety gears as required.

4.2.11 Water Supply and Sanitation Act No. 12 of 2009

This is also a new legislation that provides for sustainable management and adequate operation and transparent regulation of water supply and sanitation services; provides for establishment of water supply and sanitation authorities as well as community owned water supply organizations; and provides for appointment for service providers. The main aim of this law is to ensure the right of every Tanzanian to have access to efficient, effective and sustainable water supply and sanitation services for all purposes by taking into account

among others protection and conservation of water resources and development and promotion of public health and sanitation; and protection of the interest of customers. Under this law, the Minister responsible for water affairs shall establish water authority and cluster water authorities in order to achieve commercial viabilities.

4.12 Engineers Registration Act and its Amendments 1997 and 2007

The Acts regulate the engineering practice in Tanzania by registering engineers and monitoring their conduct. It establishes the Engineering Registration Board (ERB), the law requires any local or foreigner engineer to register with ERB before practicing in the country. Project developer will continue to comply as it has utilized the services of registered engineering firm for its structural designs which it will continue to use to supervise the construction process.

4.2.13 Contractors Registration (Amendment) Act, 2008

The Contractors Registration Act requires contractors to be registered by the Contractors Board (CRB) before engaging in practice. It requires foreign contractors to be registered by the Board before gaining contracts in Tanzania. Project Developer shall comply with the law requirement during the recruitment of contractors for project implementation.

4.2.14 Architects and Quantity Surveyors Act (1997)

The Act requires Architects and Quantity Surveyors to be involved in the project to be registered by the Architects and Quantity Surveyor Board (AQSB) before engaging in practice. It also requires foreign contractors to be registered by the Board before gaining contracts in Tanzania. Project Developer has complied with the law requirement during the recruitment of architects who have designed the project and will continue to utilize registered persons in the project implementation.

4.2.15 Urban Planning Act (2007)

The law provides for the orderly and sustainable development of land in urban areas, to preserve and improve amenities; to provide for the grant of consent

to develop land and powers of control over the use of land and to provide for other related matters. Under Section 3, among others the law seeks to improve level of the provision of infrastructure and social services for sustainable human settlement development. This act established planning authorities which include the city, municipal, town and township councils in the country which have responsibilities including:

- Secure the orderly and environmentally sustainable development of area under its jurisdiction;
- Prepare general and detailed planning schemes;
- Control building densities and access to buildings;
- Recommending approval of building schemes and subdivision of plots by developers;
- Secure cooperation of all agencies, utility bodies, land owners and other bodies and institutions involved in the preparation and implementation of planning process;

4.2.16 Public Health Act (2009)

Provide for the promotion, preservation, maintenance of public health with a view to ensuring the provisions of comprehensive, functional and sustainable public health services to the general public. Part III (e) of the act requires premises owners to keep their premises free of mosquitoes and other disease vectors, vermin or causative agents; Section 54 prohibits causing or suffering from nuisance likely to be injurious or dangerous to health, land, premises, air or water; Part IV (c) assigns responsibility to City council to remove or appoint an agent to collect, transport and dispose solid and liquid waste and charge fees to beneficiaries of this service and responsibilities for prescribing types of wastes and guidelines for their collection and disposal; Section 101 it gives rights to any private sewer to connect it to any available public sewer to discharge foul or storm water therefore the project may connect to and discharge sewage or storm water into the available trunk main. However, the quality of the sewage should be as per agreed with the water authority.

The Contracting Authority will ensure that the project design, construction and operation do not constitute a nuisance; meets the requirements meets public health requirements.

4.2.17 Urban Planning Regulation 2018

The Planning and Space Standards recommended minimum size for solid and liquid waste disposal at collection point/centre to be 400 m².

4.2.18 World Bank guidelines for Environmental Management

The main objective of this EMP is to establish a set of mitigation and monitoring measures to minimize the adverse social and environmental impacts that can take place during the implementation stage of the subproject. The measures especially focus on sensitive receptors or sensitive locations. The EMP also provides specific information about the monitoring program during construction stage including locations, frequency and reporting process. This project complies with these guidelines as it has ESMP which contains mitigation and monitoring plans of the identified impacts.

5.0 PROJECT ACTIVITIES

5.1 Mobilization or pre-construction phase

This phase entails mobilization of labour force, and equipment as well as acquisition of various permits as required by the law.

Other activities during this phase include;

- Topographical Survey for setting out purposes,
- Construction Materials' source Investigation,
- Land acquisition,
- Material storage and material preparation,

Duration

This phase is expected to take a total of three (3) Months.

5.2 Construction phase

During this phase a number of activities will be conducted, the following is the list of activities expected to be carried out during this phase;

- **Site Clearance:** The contractor shall clear the construction areas within the site of all bushes, roots, boulders, natural obstructions, rubbish and any other natural or artificial obstructions, which would interfere with construction of buildings, roads, paths and drains.
- **Excavation:** Excavations for foundations and the reinforced concrete structure shall be to the widths, depth and levels to accommodate the structure shown on the drawings. Working space has been allowed for in the measurement of excavation quantities given in these Bills of Quantities in accordance with the rules of measurement laid down elsewhere in these Bills, namely 1.00 meter from the face of any work which requires formwork over 1m deep below the starting level of excavation, and 0.30 meter from face of any work which requires formwork not exceeding 1 meter deep below starting level of excavation.
- **Filling:** The fill shall be clean, selected coarse sand or gravel. It should be taken from borrow pits if the soil on the site is found to contain too much fines and to have too low plasticity limit to be used as fill.
- **Soil Sterilization:** Anti-termite treatment is to be carried out by an approved specialist firm who will be required, upon completion of the soil sterilization, to furnish a written guarantee qualifying the following:
 - That the chemicals applied comply with the requirements and concentration (The chemicals used shall be one of the following: Aldrin 0.5% applied in oil solution or water emulsion, Benzene hexachloride, 0.8% of gamma isomer applied in oil solution or water emulsion, Chlordane 1.0% applied in solution or water emulsion, Dieldrin 0.5% applied in oil solution or water emulsion, Lindane; 0.8% in oil solution or water emulsion, Pentachlorophenol; 5% in oil solution, Trichlorobenzene; 1 part to 3 parts oil.

- That the treatment will remain effective against termite infestation for a period of five years.
- The free re-treatment by the firm of any areas showing signs of infestation before the expiry of the five-year period.
- **Disposal of surplus excavated material:** Surplus excavated material will be carted away from the vicinity of the walls and deposited, spread and levelled on areas to be allocated by the Structural Engineer, reasonably adjacent to the site.
- Concrete work:
- Steel fixing:
- Formwork preparation:

Alternative source of Energy

During this phase the alternative source of energy is the generator which will be stand-by during power outage from TANESCO.

Duration

This phase is expected to take a total of Six 6 Months.

5.3 Demobilization phase

This phase will involve the dismantling of temporary structures such as scar forming and removing/spreading spoil materials for proper restoration of the site.

Other activities include;

- General cleanliness of the area that is clearance of all sorts of solid wastes (plastics, wood, metal, papers, etc.)
- Deposit all wastes to the authorized dumpsite

5.4 Operation phase

The phase entails the actual usage of the toilet. Supply of water and toilet cleaning materials (disinfectants) are among the essentials for running the facility. Faecal sludge will be desludged using vacuum takers and disposed of at waste stabilization ponds for further treatment. The Ubungo municipality will decide on the mode of running the toilet for instance instituting fee,

Standby attendants will be positioned to oversee the day to day running of the facility.

5.5 Decommissioning Phase

Decommissioning is not anticipated in the foreseeable future as the completed facility will be serving a lot of people from; the bus stand and the nearby market, bodaboda drivers and the passersby who at present use the existing public toilet but it do not suffice. However, if this will happen, may entail change of use (functional changes) or demolition triggered by change of land use.

6.0 PROJECT DESIGN

6.1 Toilet Design

The project intends to establish the Modern Public Toilet at Magomeni Garden, Magomeni ward in Kinondoni Municipality. About 22 units each with different size and type of service ranging from urinals, bidets, WCS, HWB, showers, lobby, storage room and office space, (*Technical guidelines for construction of institutional and public toilets 2012*). The Proposed Project site covers an approximately area of 120m². The project is one single multipurpose facility aimed at providing services to the community. Pertinent area of each cube/partition with their number in the facility is as described in Table 2

Furthermore, the project will involve the construction of raiser for elevated water storage tank to build adequate pressure for proper functioning of the facility.

Table 2: The Proposed standard Public Toilet working spaces with their respective areas

Cube/partition	Unit area(m ²)	Number of units in the Facility
Ladies toilet	24.5	6
Gents Toilet	24.5	4
Disabled	6	2
Janitor	3.6	1
Store	3.6	1
Ladies shower	5.5	3
Gents Shower	5.5	3
Lobby	17	1
Reception	2.6	1
TOTAL	92.8	

6.1.1 Design approach

- The basic idea of volumetric composition is based on emphasizing the entrance without affecting the privacy and security of the public.
- The building is designed with a connection of two volumes: the front entrance space and the functional toilet area to give comfort.

Occupants waiting area are at the right and left side of the toilet which are not seen from the entry area into the toilet.

6.2 Layout Plan

The toilet layout plan is given in Figure 5, and other detailed architectural drawings are found in appendix III. The project is a simple structure that shall be constructed using block works, corrugated iron sheets and wooden members for doors.

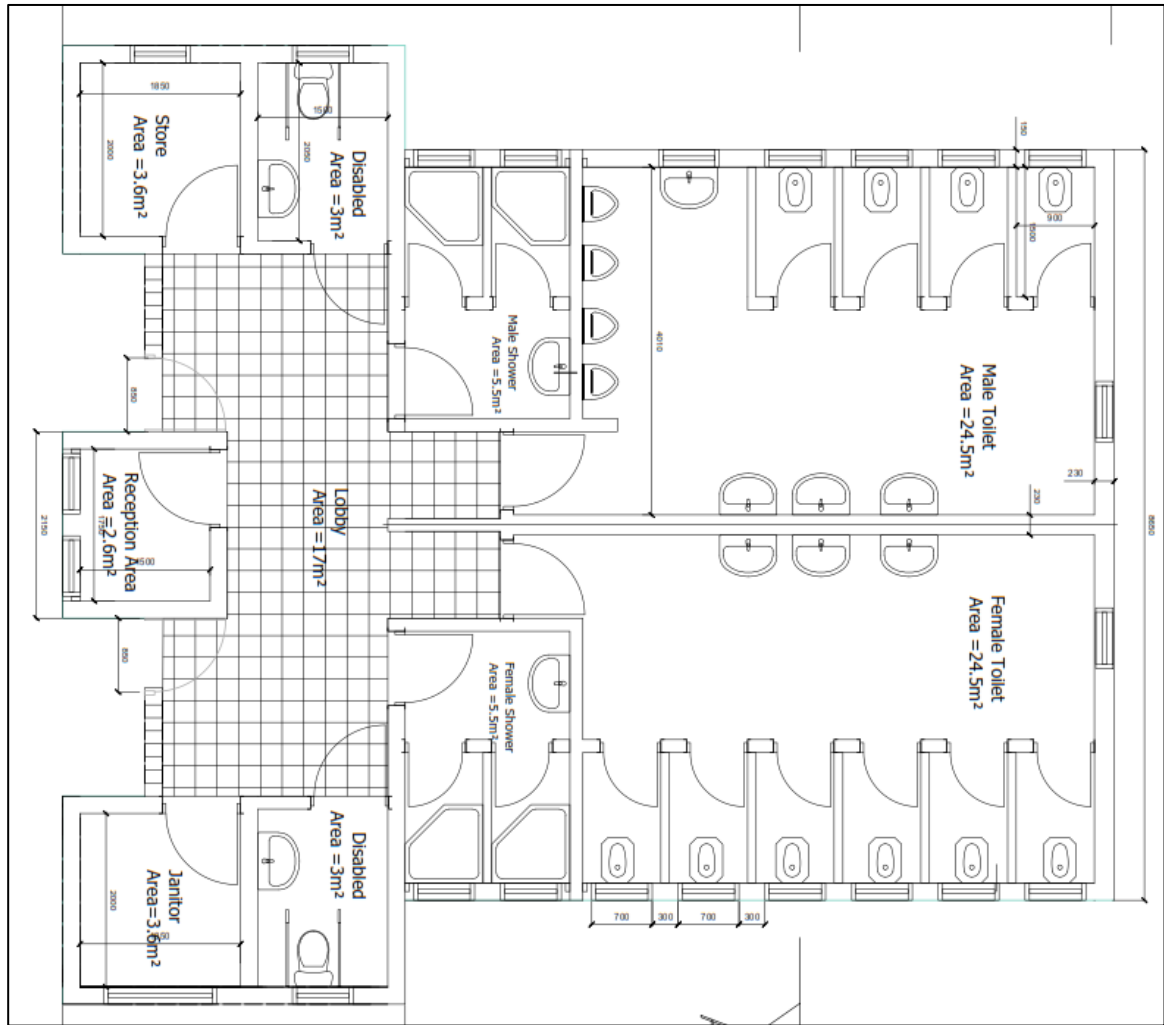

Figure 5: Floor Plan for Public Toilet

7.0 PROJECT REQUIREMENTS AND WASTE GENERATION

7.1 Project requirements

7.1.1 Construction materials and labour force

The main materials for Public toilet include cement, aggregates (stones), water, steel, sand, timbers, blocks, uPVC pipes, IPS Pipes and gravels. All materials are available in the local sources in Tanzania. (Estimate will be provided in the BOQ). Therefore, most of the material will be acquired from registered local vendors. The preliminary estimates of the material needed are summarized in table 3.

Table 3: Quantities of construction Materials

Requirements	Type	Approx. Quantity required
Substructure	Hardcore	114m ³
	Concrete	249 m ³
	Reinforcements	500 m ³
Frame	Hardcore	114m ³
	Concrete	249 m ³
	Reinforcements	500 m ³
Walling	230mm thick Block wall	83 m ²
	150mm thick Block wall	159 m ²
	100mm thick Block wall	83 m ²
Roofing	150x150 Rafters	127m
	150x150 Tie Beams	110m
	150x150 King posts	27m
	150x150 Struts	213m
	100x50 Thick wall plates	36m
	50x50 Purlins	123m
	240x20 Thick stained black fascia badge boards	54m
	150mm Half round UPVC rainwater gutter	28m

Requirements	Type	Approx. Quantity required
	fixed to fascial board	
	100mm Diameter UPVC rainwater downpipe	15m
Windows and Doors	Door size 850 x 2400mm high	11 Nos
	Door size 850 x 1900mm high	14 Nos
	Window size 1300 x 1500mm High	1 Nos
	Window size 775 x 1500mm High	2 Nos
	Window size 700 x 500mm High	20 Nos

7.1.2 Labour force

The labour force will be determined by the Contractor; nevertheless, it is projected that during the construction phase the project will require not less than 50 workers both skilled and non-skilled laborers for each phase of project construction. During operational phase it is estimated that 10 unskilled and semi-skilled workers will be retained for operating the facility.

7.1.3 Machinery and Equipment

The proposed project development will employ various standard construction equipment and machinery. Equipment expected to be used during the construction works are Tippers, Concrete Mixers, poker vibrators, Wheel barrow, Compactor, etc. All equipment and machineries for construction works needed by the proposed project will be determined when the bill of quantities (BOQ) and selection of Contractor is finalized. This equipment shall be temporary and shall be demobilized once project is completed. On the other hand the hand tools which will be used during construction phase constitutes; Shovels, hoes, hammer, pickaxe, buckets etc.

7.2 Wastes generation

The major wastes generation associated with the project are spoil soils resulting from earthworks during the foundation excavations, solid wastes and liquid waste. The spoil soil shall be stock piled around the public toilet for further use in landscaping the site at the end of the project.

6.2.1 Liquid waste management

A total of 3.2 m³ per day of liquid waste is estimated to be generated from temporary lined pit latrines during construction phase. The project construction and operations will conform to the National Effluent Standard of Tanzania which includes pre-treatment through septic tanks before emptying and transportation of sewage to the treatment facility. After the sewage treatment process is done, the effluent which is rich in nutrients is expected to cater for irrigation activities adjacent to the treatment facility. However, in case the nutritious effluent is not used for irrigation, there is a possibility of discharging direct to the receiving water body.

6.2.2 Solid waste management

About 50-100Kg per month of domestic refuse and other solid wastes is estimated to be generated during the construction phase. A well-established solid waste collection system will be instituted. The system will involve among other things wastes segregation at source, recycling or reuse of some wastes and final disposal to the approved dumpsite/landfill.

The project management team will provide waste bins and recycling receptacles of different type to enable sorting. Compostable materials will be sent direct to the city dumpsite area. Table 4 below shows solid and liquid waste wastes to be generated by the project and the methods of their disposal.

Table 4: Management of construction and operation wastes

SOLID WASTE			
Type of waste	Sources	Estimated Quantity- Kg	Disposal / Management procedure
Debris and Rubble (overburden)	Site clearance	3,000-5,000	Fill material for road potholes, etc.
Biodegradable materials mainly domestic waste (food, paper, wood etc.)	Construction crew	20-40 per day	Accessible litter bins within the camp site and later to the city waste disposal system (engage a private company)
Non-biodegradable materials (plastic, glass)	Construction crew	2-5 per day	Recycling/reuse (Plastics to be sent to plastic recyclers and glass bottles to be sent to glass recyclers)
Construction waste	Resulted from masonry work, carpentry work and painting		Recycling/reuse
Hazardous wastes (scrap metals, oil, and batteries)	Construction activities and machineries		Collected and transported by the registered dealers who have permits from Ministry responsible for Environment.
LIQUID WASTE			
Excreta (domestic wastewater) human and Grey water /cleaners	Toilets and floor cleaning	3.2 m ³ per day	Use of septic tanks and when full will empty to the wastewater treatment facility

PROJECT ALTERNATIVES

Consideration of project alternatives is crucial in ensuring that the developer and decision-makers have a wider base from which they can choose the most appropriate option. In this comprehensive project brief, the following alternatives are considered.

No project alternative

The no project alternative entails retaining the current status quo without developing the proposed public toilet. Adopting this option would mean avoiding most of the negative effects associated with the establishment of the toilet and missing all the positive benefits that would accrue such as improved community life and reduction of the communicable diseases.

Other project alternative

Other alternative that would have been used includes the rounded floor plan as a new nature of building and using of other onsite wastewater treatment technologies such as ABR.

Analysis of alternatives: To improve the public health at Magomeni Garden and surrounding community, DAWASA and LGA selected the aforementioned location, which until this more is considered to be favorable place due to a need of the toilet. Moreover, the selected design of this toilet and technology for onsite wastewater treatment were chosen by considering the nature of the place and demand of surrounded community.

8.0 POTENTIAL IMPACTS

8.1 Mobilization Phase

8.1.1 Positive impacts

8.1.1.1 Employment opportunities

Labour force for the project will be originated from Magomeni ward and the surrounding communities particularly business people using the Magomeni Bus Stand. Even though during construction the employment will be on short term basis, employees will have been benefiting from the project. Some will witness their incomes and family level of life improved.

8.1.2 Negative impacts

8.1.2.1 Noise pollution

Noise pollution is likely to occur due to the application of construction equipment and generators at the site.

Mitigation Measure

- The proponent shall maintain equipment in good running conditions to ensure that ambient noise level and vibrations pollution into the environment are minimum to comply with Tanzania standards.
- The noisy construction activities will be scheduled at normal working hours. Regular inspection and maintenance of construction vehicles and equipment will be done to ensure that they have mufflers installed and worn parts are replaced

8.1.2.2 Air Pollution from dust emission

Air pollution is likely to occur due to the emission of suspended particulate matter (dust) to the atmosphere from the construction activities.

Mitigation Measure

- Mixing equipment shall be sealed properly and vibrating equipment will be equipped with dust removing devices.
- Also all vehicles that generate excessive black smoke will not be used.
- Adequate training and use of personal protective equipment (PPE) such as eye glasses and dust masks will be ensured in order to reduce risks associated with dust.

8.2 Construction Phase

8.2.1 Positive Impacts

8.2.1.1 Employment opportunities

Labour force for the project will be originated from Magomeni ward and the surrounding communities particularly business people using the Magomeni

Bus Stand. Even though during construction the employment will be on short term basis, employees will have been benefiting from the project. Some will witness their incomes and family level of life improved.

8.2.1.2 Improved living conditions and economic growth

The project will improve the living conditions in Kinondoni Municipal whereby the project operation phase will do away with open urination. The charged fee for using the facility will be such as affordable by the intended user. Thus, there will be dignity and increased money circulation that result into increased income consequently better standard of living of people in the project area.

8.2.1.3 Improved public health

In crowded areas particularly Magomeni Bus stands, it is normally hard to ensure safety to public health without the establishment of sound infrastructures. With the public toilet at crowded areas like markets and bus stands which offers a number of services under one umbrella, it is anticipated that the general health condition will not be endangered from health risks.

8.2.1.4 Increased socio-cultural interaction

Increased socio-cultural interaction is another anticipated positive impact. The implementation of the project will bring many people from different cultural backgrounds. The interactions may bring about social changes in the communities around the project areas. Interaction with technocrats as a result of new immigrants (customers) into the area will stimulate adoption of the new technologies.

8.2.1.5 Increased Revenue to the nation through taxes, both direct and indirect

The public toilet facility constructed by DAWASA is expected to be operated by the Kinondoni Municipal. Therefore, it is expected to increase government revenue collection at Municipal and at National level. This will be enhanced by time to time payment of service by users. The revenue collected will

contribute towards economic development within the municipal and the country at large.

8.2.2 Negative impacts

8.2.2.1 Increased HIV/AIDS and other sexual related diseases:

Local communities surrounding the project area have to be aware of the fact that HIV/AIDS is present in their areas but accede to it not being at an alarming rate. The communities were worried that with an influx of people into the project area the pace of spread will accelerate especially during the construction phase.

Mitigation Measures

- Contractor shall enforce a code of conduct in the project area to encourage respect for the local community and to maintain self-cleanliness of the working area at all times.
- The contractor shall deploy locally available labour to reduce risk of spreading communicable diseases (especially STDs).
- In order to prevent more HIV/AIDS infection, during the implementation phase, the project should include information education and communication component (IEC) in its budget. This will help to raise more awareness on HIV/AIDS, and means to suppress its incidence.
- A safety, health and environment induction course shall be conducted to all workers, putting more emphasis on HIV/AIDS, which has become a national disaster.

8.2.2.2 Destruction and infringement of properties

Within and adjacent to the proposed project site there are small and temporary structures made from wood nailed with steel sheets and solid waste collection point. Such temporary structures accommodate the existing

small businesses especially food vendors (*Mamantilie*), shops, kiosks and mini-supermarkets. Therefore construction of the Public toilet might necessitate the destruction of such facilities.

Mitigation Measures

- Close supervision of construction works shall be observed in order to confine land clearance within the area where the construction activities are to take place to avoid unnecessary demolition.

8.2.2.3 Noise pollution

Noise pollution is likely to occur due to the application of construction equipment and generators at the site.

Mitigation Measure

- The proponent shall maintain equipment in good running conditions to ensure that ambient noise level and vibrations pollution into the environment are minimum to comply with Tanzania standards. Such standards are 75dBA for an average noise level and 5mm/s PPV for ground vibration at all times.
- The noisy construction activities will be scheduled at normal working hours. Regular inspection and maintenance of construction vehicles and equipment will be done to ensure that they have mufflers installed and worn parts are replaced

8.2.2.4 Air Pollution from dust emission

Air pollution is likely to occur due to the emission of suspended particulate matter (dust) to the atmosphere from the construction activities.

Mitigation Measure

- Mixing equipment shall be sealed properly and vibrating equipment will be equipped with dust removing devices.
- Also all vehicles that generate excessive black smoke will not be used.
- Adequate training and use of personal protective equipment (PPE) such as eye glasses and dust masks will be ensured in order to reduce risks associated with dust.

8.2.2.5 Potential communicable diseases transmission

Many people from different places and of different health status will be using the toilet. This creates a premise for potential transmission of different communicable diseases of wide range including diarrheas, typhoid, COVID-19 etc.

Mitigation measures

- Ensure supply of adequate provisions like water, toilet papers, soaps, disinfectants etc
- Maintain high level of cleanliness
- Install guidelines on the usage of toilets

8.2.2.6 Smells and flies in toilets

Inadequate attention to the public toilet may render the facility a liability to adjacent land users and businesses. Drainage system blockage due to misuse of toilet can be a source of sewage overflows and hence the area around becoming a nuisance to people. Overflowing sewage will produce awful smell of decomposing organic matter that lowers the air quality in the vicinity. Experience shows that, abandoned public toilets in Tanzania easily become centers for vagabond boys to plan evil acts in the society.

Mitigation measures

- The developer to ensure adequate supply of provisions
- Adhere to good maintenance
- Timely desludging

8.2.2.7 High Risk of Health associated with construction work

Construction activities exposes the workers to a lot of risks for example risk of falling into the excavated pits more than 3 meters deep, risk of injuries from falling objects or sharp pointed objects etc.

Mitigation measure

- The project proponent shall ensure that all personnel are provided with appropriate protective gear.
-

- All works shall be planned and conducted in accordance with relevant OHS Guidelines. First Aid Kit as well as regular medical check-ups for the workers will be provided during the entire working hours.
- Adequate number of firefighting equipment/extinguishers will be provided in every few distance to help putting off fire in case of occurrence.
- Excavated pits should be protected by warning tape and guardrails to prevent workers from falling

8.2.2.8 Waste generation during construction

A lot of waste will be generated especially during construction stage. For example excavation of foundations will generate a lot of spoil materials that will need to be disposed of. Construction of walls and roof will both generate wastes. Other wastes will be generated from cleaning of construction equipment and containers like mixers and paint buckets.

Mitigation measures

- Stick to the design specifications
- Provide waste containers
- Provide training to workers and orient them towards environmental protection values

8.2.2.9 Groundwater contamination from soil sterilization

Ground water contamination from soil sterilization chemicals is likely to occur because some of the chemicals listed above are toxic to animal and plant life.

Mitigation measures

- Stick to the design specifications
 - Chemicals must be applied only with caution by an experienced person
 - Treatment shall not be made when soils of fill are excessively wet or immediately after heavy rain.
-

- Precautions must also be taken to prevent disturbance of the treatment by animals or human contact with the treated soil.
- The treated area is to be covered as quickly as possible after treatment.
- The rate of application is to be 5 litres per square metre and the areas measured include those under floor and round wall and column foundations.

8.3 Operation Phase

8.3.1 Positive Impacts

8.3.1.1 Improved social-economic livelihood and dignity within the beneficiary society

The project will improve the living conditions in Kinondoni Municipal specifically at Magomeni bus stand whereby the project operation phase will do away with open defecation and urination. Thus, there will be increased money circulation that result into increased income consequently better standard of living of people in the project area.

8.3.1.2 Increased Revenue to the nation through taxes, both direct and indirect

Kinondoni Municipal is expected to increase its revenue collection on implementing this project. This will be through daily payment of facility usage services by the respective customer. The revenue collected will contribute towards implementation of other development projects.

8.3.2 Negative Impacts

8.3.2.1 Smells and flies in toilets

Inadequate attention to the public toilet may render the facility a liability to adjacent land users and businesses. Drainage system blockage due to misuse of toilet can be a source of sewage overflows and hence the area

around becoming a nuisance to people. Overflowing sewage will produce awful smell of decomposing organic matter that lowers the air quality in the vicinity. Experience shows that, abandoned public toilets in Tanzania easily become centers for vagabond boys to plan evil acts in the society.

Mitigation measures

- The developer to ensure adequate supply of provisions
- Adhere to good maintenance and good housekeeping
- Timely desludging

8.3.2.2 Health Risks to Cleaners

Cleaners who will be attending the public toilet are likely to be exposed to high risks of communicable diseases. Their work environment is at high risk of fecal contamination.

Mitigation measures

- The project proponent shall ensure that all cleaning personnel are provided with appropriate protective gear like gloves and masks.
- There will be good supply of appropriate disinfectants to be applied to contaminated surface for the purpose of killing germs
- Awareness seminar shall be given to cleaner once every six months apart from an obligatory induction course.

9.0 ACTION PLAN FOR PREVENTION AND MANAGEMENT OF ACCIDENTS DURING IMPLEMENTATION STAGE

The project shall be implemented in compliance to labour laws in Tanzania, in particular, the Occupational Health and Safety Act (2003). Clauses to protect the health and safety of workers shall be included in the contract documents for implementation stage.

9.1 Occupational Health and Safety

The proponent is committed to protect the health and safety of its employees and those of its contractors, to ensuring that activities are conducted in a

manner that protects the environment and people. The Contractor shall provide and enforce the use of appropriate personal protective equipment for all workers e.g. overalls, gloves, masks, etc. (wherever required). Tanzanian/international construction standards will be followed for quality and safety to workers. First aid facility will be installed at the construction site.

9.1.1 Emergency preparedness Plan

The proponent is committed to ensure the availability of the emergency preparedness plan in place prior to commencement of construction phase. Among others the plan should contain; identified risks, Team Build up, Availability of critical information, updated alert and response procedures and ensuring that the plan is working by putting it to some tests.

9.2 Security

The whole proposed project will take care of security matter of the site by fencing the whole project area and provide gates for entrance and exit purpose. The project proponent shall have a 24 hours security services from a private company to secure the whole project premise at the site. Also since the nature of investment involves fecal sludge management facility with the potential of biogas production. The project proponent will install the best firefighting system at site. The purpose of fire protection is to protect life, good and activities within the project site.

The following are some of the active and passive fire fighting equipment that will be employed;

- Fire detection system
- Fire hydrant system
- Portable Fire Extinguishers

9.3 Monitoring, Maintenance and repair

The management of the facility will be upon both DAWASA and Kinondoni Municipal Council to ensure the approved design or plan is implemented accordingly. Furthermore, provision of basic services is being executed at high quality as intended for. However, the facility users will also have to

ensure they are responsible with the common matters such as general cleanliness of the facility through; thorough flushing after use, avoid disposing diapers and littering within the toilet sink, paying service fees, etc

10.0 ENVIRONMENTAL AND SOCIAL MANAGEMENT PLAN

10.1 Environmental and Social Management Plan

The Environmental and Social Management Plan (ESMP) presents the implementation schedule of the proposed mitigation measures for both environmental and social impacts. The ESMP for the proposed Construction of Public Toilet at Magomeni Garden is summarized in Table 5. The ESMP also indicates environmental costs needed to implement the recommended mitigation measures. The public toilet site selection process and engineering designs have already included some of the mitigation measures recommended in this report. Additional recommendations are provided in the ESMP to enable the public toilet to be constructed and operated in environmentally friendly manner.

DAWASA in collaboration with Kinondoni Municipality shall be the main implementer of the ESMP through. The environmental measures incorporated in the detailed engineering design will be attached to the Bills of Quantities and Contract Documents. Moreover, there will be an Environmental, Social, Health and Safety (ESHS) Code of Conduct to be signed by the Contractor(s) to show their commitment in the implementation of the Environmental, Social, Health and Safety. The implementation of the Code will be supervised by DAWASA or his consultant.

The ESHS Code is a set of Guidelines attached to the Bidding Document and Contract to be adopted by Contractor during project implementation. It contains the commitment and obligations of the Contractor and its subsidiaries (i.e. Sub-Contractors and staff) to undertake construction activities in accordance with all applicable Laws, Rules, and Regulations. The Contractor and its subsidiaries shall comply with the Code of Conduct with

high ethical standards. Failure to observe the Code, will subject the firm to disciplinary action, including Contract termination. Violation of the Code, is violation of Law which may result to civil and/or criminal penalties to Contractors, Supervisors or Firm.

Some of the issues to be included in the ESHS shall include;

- Site specific **ESMP, HSMP,**
- Traffic Management Plan (**TMP**), **where applicable**
- HIV/AIDS Awareness Program,
- Occupational Health and Safety Awareness Program.
- Sexual Harassment prevention Policy
- Child Labour Prevention Policy

The environmental and social mitigation and enhancement measures incorporated in the detailed engineering design will be attached to the Contract Documents. The Contractor shall take stock of the contents of the Project Brief.

Table 5: Environmental and Social Management Plan for the Proposed Construction of Public Toilet at Magomeni Garden, Magomeni ward, Kinondoni Municipality

Impact	Mitigation Measure	Responsible Institution	Estimated One Time Cost (TZS)	Estimated Annual cost (TZS)
Mobilization Phase				
Increased waste generation	<ul style="list-style-type: none"> Stick to the design specifications Provide waste containers Provide training to workers and orient them towards environmental protection values 	Contractor/DAWASA/ Kinondoni Municipal Council	To be included in the BOQ	
Noise pollution during construction	<ul style="list-style-type: none"> The proponent shall maintain equipment in good running conditions to ensure that ambient noise level and vibrations pollution into the environment is very minimum to comply with Tanzania standards All construction works will be scheduled at normal working hours. Proper inspection and maintenance of construction vehicles and equipment will be done to ensure that they have mufflers installed and worn parts are replaced 	Contractor/DAWASA/ Kinondoni Municipal Council	500,000.00	
Construction Phase				
Increased waste generation	<ul style="list-style-type: none"> Stick to the design specifications Provide waste containers Provide training to workers and orient them towards environmental protection values 	Contractor/DAWASA/ Kinondoni Municipal Council	To be included in the BOQ	

Impact	Mitigation Measure	Responsible Institution	Estimated One Time Cost (TZS)	Estimated Annual cost (TZS)
Increased HIV/AIDS and other STD	<ul style="list-style-type: none"> • Contractor shall enforce a code of conduct in the project area to encourage respect for the local community and to maintain self-cleanliness of the working area at all times. • The contractor shall deploy locally available labour to reduce risk of spreading communicable diseases (especially STDs). • In order to prevent more HIV/AIDS infection, during the implementation phase, the project should include information education and communication component (IEC) in its budget. This will help to raise more awareness on HIV/AIDS, and means to suppress its incidence. • A safety, health and environment induction course shall be conducted to all workers, putting more emphasis on HIV/AIDS, which has become a national disaster. 	Contractor/DAWASA/ Kinondoni Municipal Council	5,000,000.00	
Land degradation and increased erosion	<ul style="list-style-type: none"> • The contractor should pave the walkways prone to erosion whose quantities are shown in the BoQ • To obtain the construction materials official negotiated should be performed with wards leaders in order to avoid conflict. 	Contractor/DAWASA/ Kinondoni Municipal Council	25,000,000	

Impact	Mitigation Measure	Responsible Institution	Estimated One Time Cost (TZS)	Estimated Annual cost (TZS)
Noise pollution during construction	<ul style="list-style-type: none"> The proponent shall maintain equipment in good running conditions to ensure that ambient noise level and vibrations pollution into the environment is very minimum to comply with Tanzania standards All construction works will be scheduled at normal working hours. Proper inspection and maintenance of construction vehicles and equipment will be done to ensure that they have mufflers installed and worn parts are replaced 	Contractor/DAWASA/ Kinondoni Municipal Council	1,000,000.00	
Dust generation during construction	<ul style="list-style-type: none"> Mixing equipment shall be sealed properly and vibrating equipment will be equipped with dust removing devices. Also all vehicles that generate excessive black smoke will not be used. Adequate training and use of personal protective equipment (PPE) such as eye glasses and dust masks will be ensured in order to reduce risks associated with dust. 	Contractor/DAWASA/ Kinondoni Municipal Council	3,000,000.00	
Health Risks associated with construction works	<ul style="list-style-type: none"> The project proponent shall ensure that all personnel are provided with appropriate protective gear. 	Contractor/DAWASA/ Kinondoni Municipal Council	3,000,000.00	

Impact	Mitigation Measure	Responsible Institution	Estimated One Time Cost (TZS)	Estimated Annual cost (TZS)
	<ul style="list-style-type: none"> All works shall be planned and conducted in accordance with relevant OHS Guidelines. First Aid Kit as well as regular medical check-ups for the workers will be provided during the entire working hours. Adequate number of firefighting equipment/extinguishers will be provided in every few distance to help putting off fire in case of occurrence. Excavated pits should be protected by warning tape and guardrails to prevent workers from falling The developer to ensure adequate supply of provisions Adhere to good maintenance 			
Demobilization phase				
Noise pollution during construction	<ul style="list-style-type: none"> The proponent shall maintain equipment in good running conditions to ensure that ambient noise level and vibrations pollution into the environment is very minimum to comply with Tanzania standards All construction works will be scheduled at normal working hours. Proper inspection and maintenance of construction vehicles and equipment will be done to ensure that 	Contractor/DAWASA/ Kinondoni Municipal Council	500,000.00	

Impact	Mitigation Measure	Responsible Institution	Estimated One Time Cost (TZS)	Estimated Annual cost (TZS)
	they have mufflers installed and worn parts are replaced			
Operational Phase				
Health Risks associated with construction works	<ul style="list-style-type: none"> The project proponent shall ensure that all personnel are provided with appropriate protective gear. All works shall be planned and conducted in accordance with relevant OHS Guidelines. First Aid Kit as well as regular medical check-ups for the workers will be provided during the entire working hours. Adequate number of firefighting equipment/extinguishers will be provided in every few distance to help putting off fire in case of occurrence. Excavated pits should be protected by warning tape and guardrails to prevent workers from falling The developer to ensure adequate supply of provisions Adhere to good maintenance 	Contractor/DAWASA/ Kinondoni Municipal Council	Depend on the operational manual	
Total			38,000,000.00	38,000,000.

11.0 MONITORING PLAN

11.1 Environmental Monitoring

The national EIA guidelines require the developer to prepare and undertake monitoring plan of implemented development projects. Monitoring is needed to check if and to what extent the impacts are mitigated, benefits enhanced and new problems addressed. Recommendations for monitoring have been included in the Table 6. The monitoring plan also assigns responsibilities for different actors. Moreover, the ward and street environmental committees will shoulder the long-term monitoring of the project.

Table 6: Monitoring Plan for the Proposed Construction of Public Toilet at Magomeni Garden, Magomeni Ward, Kinondoni Municipality

Parameter	Monitoring Frequency	Sampling Area	Measurement Unit	Method	Target Level/Standard	Responsibility for monitoring	Estimated Annual (or once cost (TZS)
Mobilization Phase							
Dust	Daily	Immediate working area	Presence of nuisance dust	Physical-visual	-	Contractor/Magomeni ward	None
Air Quality	Daily	Around the Inspection chambers	Presence of smells	Smelling (nasal)	Absence of nuisance smells	Magomeni Ward/DAWASA/Kinondoni Municipal Council	2,500,000.00
Waste Generation	Weekly	At the working area	Amount of waste	Physical measurement or estimation	All waste contained	Contractor/Magomeni Ward/DAWASA/Kinondoni Municipal Council	In BOQ
Health risks	Daily	At working area	Accidents	Counting	NO accident	Contractor/Magomeni Ward/DAWASA/Kinondoni Municipal Council	In BOQ
HIV/AIDS	Monthly	Workers	Training	Numbers	One per month during construction phase only	Contractor/Magomeni Ward/DAWASA/Kinondoni Municipal Council	5,000,000.00
Biodiversity	Once (at commencement)	Working area	Destruction of habitat or removal of biodiversity	Area affected	Minimal disturbance to biodiversity	Contractor/Magomeni ward/DAWASA/Kinondoni Municipal Council	1,000,000.00
Construction phase							
Dust	Weekly	Immediate working area	Presence of nuisance dust	Physical-visual	-	Contractor/Magomeni ward	None

Comprehensive Project Brief of the Proposed Public Toilet at Magomeni Garden

Parameter	Monitoring Frequency	Sampling Area	Measurement Unit	Method	Target Level/Standard	Responsibility for monitoring	Estimated Annual (or once cost (TZS))
Air Quality	Weekly	Around the Inspection chambers	Presence of smells	Smelling (nasal)	Absence of nuisance smells	Magomeni Ward/DAWASA/Kinondoni Municipal Council	2,500,000.00
Waste Generation	Weekly	At the working area	Amount of waste	Physical measurement or estimation	All waste contained	Contractor/Magomeni Ward/DAWASA/Kinondoni Municipal Council	In BOQ
Health risks	Daily	At working area	Accidents	Counting	NO accident	Contractor/Magomeni Ward/DAWASA/Kinondoni Municipal Council	In BOQ
HIV/AIDS	Monthly	Workers	Training	Numbers	One per month during construction phase only	Contractor/Magomeni Ward/DAWASA/Kinondoni Municipal Council	5,000,000.00
Biodiversity	Once (at commencement)	Working area	Destruction of habitat or removal of biodiversity	Area affected	Minimal disturbance to biodiversity	Contractor/Magomeni ward/DAWASA/Kinondoni Municipal Council	1,000,000.00
Demobilization Phase							
Dust	Weekly	Immediate working area	Presence of nuisance dust	Physical-visual	-	Contractor/Magomeni ward	None
Air Quality	Weekly	Around the Inspection chambers	Presence of smells	Smelling (nasal)	Absence of nuisance smells	Magomeni Ward/DAWASA/Kinondoni Municipal Council	500,000.00
Waste Generation	Weekly	At the working area	Amount of waste	Physical measurement or estimation	All waste contained	Contractor/Magomeni Ward/DAWASA/Kinondoni Municipal Council	In BOQ
Health risks	Daily	At working	Accidents	Counting	NO accident	Contractor/Magomeni	In BOQ

Comprehensive Project Brief of the Proposed Public Toilet at Magomeni Garden

Parameter	Monitoring Frequency	Sampling Area	Measurement Unit	Method	Target Level/Standard	Responsibility for monitoring	Estimated Annual (or once cost (TZS)
		area				Ward/DAWASA/Kinondoni Municipal Council	
HIV/AIDS	Monthly	Workers	Training	Numbers	One per month during construction phase only	Contractor/Magomeni Ward/DAWASA/Kinondoni Municipal Council	5,000,000.00
Biodiversity	Once (at commencement)	Working area	Destruction of habitat or removal of biodiversity	Area affected	Minimal disturbance to biodiversity	Contractor/Magomeni ward/DAWASA/Kinondoni Municipal Council	1,000,000.00
Operation phase							
Air Quality	Monthly	Around the Inspection chambers	Presence of smells	Smelling (nasal)	Absence of nuisance smells	Magomeni Ward/DAWASA/Kinondoni Municipal Council	500,000.00
Waste Generation	Monthly	At the working area	Amount of waste	Physical measurement or estimation	All waste contained	Contractor/Magomeni Ward/DAWASA/Kinondoni Municipal Council	In operation manual
Health risks	Monthly	At working area	Accidents	Counting	NO accident	Contractor/Magomeni Ward/DAWASA/Kinondoni Municipal Council	In operation manual
HIV/AIDS	Annually	Workers	Training	Numbers	One per month during construction phase only	Contractor/Magomeni Ward/DAWASA/Kinondoni Municipal Council	In operation manual
Total							24,000,000.00

12.0 PROJECT BUDGET

The investment cost for the proposed Public toilet is estimated to be around Tshs 300 Million that will be financed The World Bank.

13.0 STAKEHOLDER VIEWS ON THE PROPOSED PROJECT

During the conduction of this study, different stakeholders were consulted. Among these include the Kinondoni Municipal Council and community at Magomeni Garden (see Figure6). Consultations were made through meetings held on 2nd July 2020.



Figure 6: Stakeholder's consultation meeting with Magomeni Garden Sofa Makers

During the meeting, the consultant gave a brief explanation on the proposed public toilet. The project description, covered proposed location, type and design of toilet (a typical design was displayed), construction materials, fecal sludge emptying and disposal. The stakeholders were given chance give their views on the project. Moreover, the consultant offered chance to clarify issues where stakeholders wanted to be given more explanations. The comments by stakeholders were analyzed and incorporated in the design of mitigation measures. Table 7 summarizes the issues raised. The names of the stakeholders consulted are given in Appendix I and the minutes of stakeholders consultations are given in appendix II.

Table 6: Issues and concerns rose by stakeholders

Institution	Name	Position	Issues/ concerns
KINONDONI MUNICIPAL COUNCIL, MAGOMENI	ANAGRACE BUBERWA	HEALTH OFFICER	<ul style="list-style-type: none"> The public toilet at Magomeni will help to do away with open defecation and open urination
KINONDONI MUNICIPAL COUNCIL	Maduhu K. Ilaga	MUNRO-KMC	<ul style="list-style-type: none"> The designs of Public toilets has to make provision against flooding scenarios at some proposed sites like Mkwajuni

14.0 CONCLUSION AND RECOMMENDATIONS

The proposed Public Toilet project in Magomeni Ward, Kinondoni Municipality, Dar es Salaam, is regarded as a small project. The project benefits includes in the principle to improve and promote public health through proper waste management (in particular improved sanitation). When there is a good and improved sanitation, then the outbreak of diseases lie waterborne are reduced and prevented hence achieving improved public health. The facility shall also generate income to the municipality. Moreover, the proposed location of the public toilet is not in environmentally sensitive area.



The anticipated impacts identified are of small dimension and of less negativity to the community and the environment. All impacts can be mitigated through engineering practices.

Our conclusion is that implementation of the proposed construction of the public toilet at Magomeni Garden will not entail detrimental impacts provided that the recommended mitigation measures are adequately and timely put in place. The identified adverse impacts shall be managed through the proposed mitigation measures and implementation regime laid down in this EIS. DAWASA is committed to implementing all the recommendations given in the EIS and further carrying out environmental auditing and monitoring schedules.

Appendix I: List of Stakeholders Consulted



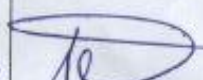
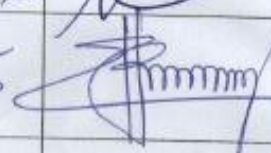
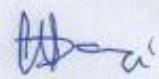

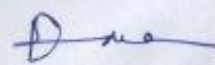

**ENVIRONMENTAL AND SOCIAL IMPACT ASSESSMENT FOR CONSTRUCTION OF OFF GRID SANITATION PROJECTS,
DAR ES SALAAM**

LIST OF STAKEHOLDERS CONSULTED

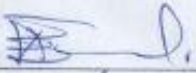
SN	DATE/TAREHE	NAME/JINA	INSTITUTION/TAASISI	POSITION/CHEO	PHONE NO./SIMU	SIGNATURE/SAINI
	20/7/2020	ARON KAGURUMIWA	KMC	MA	0767-24646	
	20/07/2020	Eng. LEOPOLD RUNJI	TARURA KMC	MENEJA	0767665005	
	20/07/2020	MSANCI M.S	KMC Environment	MEMO	0716-413058	
	20/07/2020	Kennedy Mwa	EHO-KMC	EHO	065 7853087	
	20/7/2020	Maduus Kilange	KMC	MUPU	0753650529	

ENVIRONMENTAL AND SOCIAL IMPACT ASSESSMENT FOR CONSTRUCTION OF OFF GRID SANITATION PROJECTS,
DAR ES SALAAM

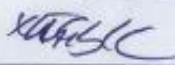
LIST OF STAKEHOLDERS CONSULTED

SN	DATE/TAREHE	NAME/JINA	INSTITUTION/TAASISI	POSITION/CHEO	PHONE NO./SIMU	SIGNATURE/SAINI
01	16/07/2020	ANAGRAJEE BUREJA	KMC	KATA-MAGOMENI AFISA AFYA	0759169828	
02	16/07/2020	ADAM MASSO	KAWAWA	MW/KITI	0715488278	
03	16/07/2020	M. FUNDIKIRA	MSOLONI SERIKALI MITAA	M'KITI	0759 605665	
04	16/07/2020	ISMAL RASHID	S. MITAN KISIWAH	M'KITI	0754 119941 0653862353	
05	16/07/2020	XIXRAXI HABIBI	KIXIKUXBUSHO	WEO - KIXIKUXBUSHO	0713967660	
06	16/07/2020	D. MSAWI	MAKUMBEHO	AFISA AFYA	0784234777	

Appendix II: Minutes of local community consultations

ITIHIMINI YA ATHARI KUWA MAZINGIRA WA JAMII NA
UTAMASISHAJI KUWA JAMII KUHUSU MRADII WA WENZI WA MAKATI
MRADALA NA FIDIA ZITOKANAZO NA MRADI WA WENZI
WA MIUNDOMBINU YA UCHAKATATI MASI TACA NA UYOO
VYA UMMA MCOA WA DAR-ES-SALAAM
(MAGOMENI GARDEN)

 16/07/2020

AGENDA

1. KUFUNGUWA KIKAO
2. MAELEZO KUHUSU MRADI WA WENZI WA CHOO CHA UMMA
3. MASWALI MAONI KUTOKA KWA WADALI
4. KUAHIRISHA KIKAO

1. KUFUNGUWA KIKAO
Kikao kilifunguliwa na mwenyekiti ndugu Mgaya
Magango unamo muda wa saa 5:00 asubuhi na
kisha kuwatabulisha wataalamu kutoka
kampani ya Royal Associate Engineering JV G-PCS
LTD, kiwa imeambatana na mwekezaji wake
DAWASA.
Baada ya utambulisho huo mwenyekiti aliwakaribisha
wataalamu kutoka maelezo ya mradi.

2. MAELEZO KUHUSU MRADI WA WENZI WA CHOO CHA UMMA
Wataalamu ndugu Robert Kishiki alisiwamana na kusema
yeye ni mshauri wa DAWASA amekuja kutoka kucarifa
kuhusu ujenzi wa choo cha umma na kwa sasa -
anagamba kithimini ya athari ya Mazingira na Jamii.

Huu mradi unajengwa na DAWASA na Manispa, choo hili kitakuwa chakulipia na ni kitatunika kwa jinsia zote wanaume na wanawake, na kitasaidia kupunguza kipindupindu.

3. MASWALI / MAONI KUTOKA KWA WADAU

Abubakari Bayajiza - Alitazwa eneo hili kuna vijana wanafanya biashara tukiwatoa hawa watu tutawapeleka wapi?

Mtakaumu alijibu temelichukua hilo kama changanoto tutayafikisha maoni yenu tutayapeleka sehemu husika ili kuwaza kulinda ajira za watu. Kama watawazi kupata eno jingine.

Abel komba - Alisema kwenye eno hili tuna vijana karibia ishirini ambao wanafanya biashara eno hili hivyo wanaomba tenkali lwafikiwe kwenye hili.

Mrina Kenned - Alijibu na kusema wao kama manispa hawatafukuza watu hivyo wafanyabiashara wanawazi kusoga pembeni kedogo la sidhani kama watafukuza wafanya biashara.

Nelson Mandela Mtokozi - Alitazwa tathmini ishafanyi mtakaumu alijibu ndio tumekuya kufanya tathmini

Madhaka Said - Alionba hapa katikati karibu na sehemu ya kuosha magari pako wazi kwanini watumie eno hilo.

Mtendaji wa eno hili alisema hakuna mtu atakaeswa hivyo wafanyabiashara wawe na amani kama kutakuwa na lobote tutawajulisha.

Mtendaji aliendelea kushukuru kwa Maoni ya wanandi.

4. KUATHIRISHA KIKAO

Kikao kilialunishwa na Muonyekiti wa kikao mnamo
Muda wa saa 5:30 asubuhi

Salihu ya Muonyekiti
Mgaya Magango

0715578457

Salihu ya Mtendaji

MEMEJ. P. PANGA
07124055 66



TATHIMINI YA ATHARI KWA MAZINGIRA NA JAMII NA UHAMASISHAJI KWA JAMII KUHUSU MPANGO WA MAKAZI MBADALA NA FIDIA ZITOKANAZO NA MIRADI WA UENZI WA MIUNDOMBINU YA UCHAKATAJI MAJI TAKA NA VYOO VYA UMMA MKOA WA

DAR ES SALAAM

MAHUDHURIO KWA AJILI YA MIKUTANO, MAJADILIANO

MWEKEZAJI: DAWASA

MISHAURI: ROYAL ASSOCIATES ENGINEERING JV G-PES LTD

TAREHE: 16/07/2020

WILAYA: KINOWUNU

KATA: MUKOWENI

MTAA: BULISSA

S/N	JINA	WADHIFA	NAMBA YA SIMU	SAHIHI
01	MENES P TEMBA	MTO	0712405564	
02	MAYA M. MATA	MUMBE KINAA	075578457	
03	ANAGRACE E BUBEGWA	AFISA AFYA	0787169828	
04	MASHAKA SAIDI	FUNDI SOFA	0702-569332	
05	SUPA F PONCLA	MFIANO BIASHARA (FUNDI)	0718-510034	
06	HASSAN I SAIB	MFIANO BIASHARA	0757506441	
07	SABIDA S Sabida	MFIANO BIASHARA (M. TILIA)		
08	NELSEN W. MUGOR	MFIANO BIASHARA	0689620051	
09	RYMADHANI OMARI	MFIANO BIASHARA	0704-987682	
10	RAMADHANI MDHAMED	MFIANO BIASHARA	065617459	
11	HASSAN JONATHAN KIMBA	MFIANO BIASHARA	072072944	
12	MUHAMME RAJABU	BONOBODO	0711754108	
13	MWANAHARUS IJAKO	MFIANO BIASHARA	0677 276929	
14	ADOLLAT HANUKE	MFIANO BIASHARA	0716 553055	
15	ABEL KIMBI	FUNDI	075-204588	
16	FRANK LAURENT	MFIANO BIASHARA	0674528591	
17	VAZIRI MBUNDA	FUNDI	0625480473	
18	INDI CHUMBA	FUNDI	0687685855	
19	ROBEB KALKE	FUNDI	07086941609	
20	BASHIRU M. MGHANAH	FUNDI	0755276160	
21	FLIKI A. HANLE	FUNDI	0689699731	
22	SAIN OMARI	FUNDI	07163662468	
23	JAMES	HATA	0719947156	

Appendix III: Permit to use the Open Space for construction of Public Toilet

HALIMASHAURI YA MANISPAA YA KINONDONI
BARUA ZOTE ZITUMWE KWA MKURUGENZI WA MANISPAA

Tel: 2170173
2171022
Fax: 2172606



MKURUGENZI WA MANISPAA
MANISPAA YA KINONDONI
S. L. P. 31902,
DAR ES SALAAM,

Unapojibu tafadhali laja:

Kumb. Na. KMC/HEALTH/A.1.7/654

Tarehe: 09 Septemba, 2020

Mtendaji Mkuu,
Mamlaka ya Maji Safi na Maji Taka,
S.L.P 1573,
DAR ES SALAAM.

**YAH: IDHINI YA MATUMIZI YA MAENEO YALIYOPENDEKEZWA KWA UJENZI WA
MIRADI YA UKUSANYAJI NA UCHAKATAJI WA MAJI TAKA.**

Tafadhali husika na mada tajwa hapo juu.

2. Tafadhali rejea barua yako yenye *Kumb. Namba DAWASA/KINO/DOC/2020/01* ya tarehe **13.03.2020** yenye mada tajwa hapo juu.

3. Nakujulisha kuwa utaratibu wa upimaji na umilikishaji wa maeneo yaliyopendekezwa kwa ajili ya ujenzi wa miradi ya ukusanyaji na uchakataji wa maji taka pia ujenzi wa vyoo vya umma katika eneo la Wilaya ya Kinondoni umekamilika maeneo hayo ni kama yalioanishwa kwenye majedwali hapo chini maeneo yaliyotolewa kwa ajili ya ujenzi wa miradi ya ukusanyaji na uchakataji wa maji taka ambayo yanayomilikiwa na Halmashauri ni.

Na.	Eneo	Kata
1.	Mabwepande	Mabwepande
2.	Makumbusho Kisiwani	Makumbusho
3.	Hanasif (Bonge la Mkwajuni)	Hanasif
4.	Tandale (Kwa Mtogole)	Tandale

Maeneo kwa ajili ya vyoo ya umma na ambayo yanamilikiwa na Halmashauri ni

Na	Eneo	Kata
1.	Soko la Mpiji Mbweni	Mbweni
2.	Kituo cha Daladala Tegeta Nyuki	Kunduchi
3.	Soko la Mbezi Beach "A"	Kawe

..	Makumbusho - Minazini	Makumbusho
5.	Soko la Tegeta Nyuki	Kunduchi
6.	Mwananyamala Msolomi	Mwananyamala
7.	Magomeni Garden	Magomeni

4. Sambamba na kuendelea na kazi ya upimaji na umilikishwaji wa maeneo yaliyopendekezwa kwa ajili ya ujenzi wa miradi ya ukusanyaji na uchakataji wa maji Taka unaruhusiwa kuanza utekelezaji wa miradi kwa kuzingatia taratibu zote.

5. Ofisi ya Mkurugenzi Manispaa ya Kinondoni itaendelea kutoa ushirikiano muda wote kwa lengo la kufanikisha utekelezaji wa miradi kwa wakati.

6. Aidha, kwa eneo lililobaki kuanzia mpaka wa eneo lililopimwa hadi Mto Mpiji linaweza kutumika kwa shughuli za mradi kama mlivyopendekeza hivyo kuwa eneo la mradi.

Nakutakia utekelezaji mwema.

K.n.y: MKURUGENZI WA MANISPAA

Dkt. Samwel Laizer

K.n.y: MKURUGENZI WA MANISPAA
HALMASHAURI YA MANISPAA YA KINONDONI

**Appendix IV: Memorandum of Understanding between DAWASA and Dar
es Salaam Municipal Councils**



MEMORANDUM OF UNDERSTANDING
BETWEEN
MINISTRY OF WATER
AND
THE DAR ES SALAAM WATER SUPPLY AND
SEWERAGE AUTHORITY,
REGIONAL ADMINISTRATIVE SECRETARIAT
AND
DAR ES SALAAM MUNICIPAL COUNCILS
(Kinondoni, Ilala, Temeke, Ubungo, Kigamboni)

JANUARY 2019

ACRONYMS

BC	Beneficiary Community
CEO	Chief Executive Officer
CPM	Critical Path Method
CV	Curriculum Vitae
DAWASA	Dar es Salaam Water and Sewerage Authority
DDCA	Drilling and Dam Construction Agency
DEWATS	Decentralized Wastewater Treatment System
DSM	Dar es Salaam
EMP	Environmental Management Plan
ESA	Environmental and Social Assessment
ESIA	Environmental and Social Impact Assessment
ESMP	Environmental and Social Management Plan
EWURA	Energy and Water Utilities Regulatory Authority
FDR	Final Design Report
FSM	Feacal Sludge Management
GIS	Geographic Information System
GoT	Government of the United Republic of Tanzania
H&S	Health and Safety
ICB	International Competitive Bidding
IFRs	Interim Financial Report
LGAs	Local Government Authorities
m ³	Cubic meter = 1,000 litres
MD	Managing Director
MKUKUTA	National Strategy for Growth and Reduction of Poverty
MoEVT	Ministry of Education and Vocational Training
MoHCDEC	Ministry of Health, Community Development, Gender, Elderly and Children
MoU	Memorandum of Understanding
MoW	Ministry of Water
NCB	National Competitive Bidding
NEMC	National Environment Management Council

NGO	Non-Governmental Organization
NWSDS	National Water Sector Development Strategy
O&M	Operations and Maintenance
PAP	Projected Affected Person
PERT	Program Evaluation Review Technique
PIM	Project Implementation Manual
PIP	Program Implementation Plan
PO	Private Operators
PO-RALG	Presidents Office Regional Administration and Local Government
PPRA	Public Procurement Regulatory Authority
RAP	Resettlement Action Plan
RAS	Regional Administrative Secretary
RS	Regional Secretariat
RFP	Request for Proposals
SDG	Sustainable Development Goal
SPS	Small Piped Water Supply
TBS	Tanzania Bureau of Standards
ToR	Terms of Reference
UWSA	Urban Water and Sewerage Authority
WC	Water Committee
WSDP	Water Sector Development Program
WSS	Water Supply and Sanitation.
WSSP	Water Sector Development Program
WSSPII	Second Water Sector Support Project

**A MEMORANDUM OF UNDERSTANDING
FOR THE IMPLEMENTATION OF THE OFF- GRID WATER SUPPLY AND
SANITATION PROJECTS UNDER THE SECOND WATER SUPPLY AND
SANITATION PROJECT USING EARMARKED FINANCING**

Memorandum of Understanding (“MoU”) between the Ministry of Water on one part and the Dar es Salaam Water Supply and Sewerage Authority (“DAWASA”), the Dar es Salaam Regional Secretariat (RS), and the five municipalities of Dar es Salaam (collectively referred to as “the MUNICIPALITIES”) on the other part.

WHEREAS in recognition of the importance and contribution of the water sector to the social and economic development of the United Republic of Tanzania, the Government has developed a water sector support framework set out in the following documentation: (a) the National Strategy for Growth and Reduction of Poverty (“MKUKUTA, as amended”), (b) the National Water Sector Development Strategy (“NWSDS”) and (c) the Water Sector Development Program (“WSSP”).

WHEREAS after being satisfied with the objectives of the WSSP II, parties to this Memorandum have expressed their willingness to participate fully in its implementation;

WHEREAS The WSSPII project development objective is to strengthen the capacity for the integrated water resources planning and management in the united Republic of Tanzania and improve access to water supply and sanitation services in an operationally efficient manner in Dar es Salaam. The project has four components namely: Integrated Water Resources Management, Dar es Salaam Water Supply improvement, Dar es Salaam Sanitation Improvement, and Project Management and Implementation support.

WHEREAS the project is being financed by IDA Credit through Investment Project Financing, the recipient has declared its commitment to the objectives of the Project.

WHEREAS on the other part DAWASA has committed itself to the principle of harmonization and strive for the highest degree of alignment with the Government’s budgetary and accountability systems and local financial framework so as to enhance effective implementation, reduce the administrative burden on the Government, and minimize transaction costs; and

NOW THEREFORE, the parties hereby agree to cooperate in coordinating the implementation of the off-grid water supply and sanitation part of WSSP II in accordance with the principles and procedures set forth in this MoU; provided, however, that in case of any conflict between the provisions of this MoU AND THE PROJECT Financing Agreement, the provisions of the Financing Agreement shall prevail.

1. DEFINITIONS

Unless the context otherwise requires, several terms defined in the Preamble of this MoU have the respective meanings set forth therein, and the additional terms referred to below have the following meanings:

1. **Off Grid water supply** means the activities which will provide water supply services to people of Dar es Salaam, who are not connected to the formal network. The proposed solutions include decentralized Interventions, which may be an interim measure to be integrated to the grid network as it expands in the future. Schemes to be implemented include mostly independent water supply distribution systems supplied from point sources (e.g boreholes) or a bulk water supply from the DAWASA distribution system. In areas where the existing grid network is not available, independent stand-alone Small Piped Water Supply (SPS) systems will be implemented. These projects, typically involve a source of water (for example, borehole), a community-based distribution system and water points at a community and/or household level. The operations and maintenance will be supported from the tariff collected from the users.
2. **Off-Grid Sanitation** means activities which will provide sanitation services in Dar es Salaam to areas without access to sewers. This activity will support installation of improved toilets; safe emptying and transportation of the waste to a treatment facility; and treatment and safe disposal of treated waste into the environment. This will include piloting decentralized systems and other new technology.
3. **Environmental and Social Management Framework or ESMF** means the framework dated September 2006, prepared by the Government and cleared by the International Development Association, setting forth an environmental and social screening process that will enable WSSP II Implementing Agencies to identify and assess potential adverse environmental and social impacts, and offset and reduce them to acceptable levels, or enhance positive impacts, and in accordance with which environmental and social management plans will be prepared by WSSP II Implementing Agencies.
4. **MKUKUTA II** Means the Government's National Strategy for Growth and Reduction of Poverty dated July 2010, covering the period from 2011 – 12 to 2016 – 17 and subsequent versions that may be introduced by GOT.
5. **Resettlement Policy Framework** or RPF means the governing framework dated September 2006, prepared by the Government and approved by the International Development Association, for land acquisition, resettlement and compensation under the WSDP, and in accordance with which resettlement action plans will be prepared,

as necessary, as the same may be amended from time to time with the concurrence of the International Development Association;

6. **WSSP Implementation Manual** means the Project Implementation Manual (PIM) specifying implementation arrangements for the Second WSSP, including institutional arrangements; procedures for procurement, disbursement of funds, financial management, environmental and social management, and monitoring and evaluation; and progress reporting requirements, including annexes to the said manual.
7. **Project Management Team** means a team set up by DAWASA for day to day management of the off-grid water supply sub-project. Same for management of off-grid sanitation sub-project.
8. **Facilitation Team** A team appointed by the Municipal Director of the respective Municipal Council from Dar es Salaam region for the purpose of facilitating the implementation of the Off-Grid water supply projects and Off- Grid Sanitation projects. The scope of their responsibility are detailed in the PIM and summarized in this MoU.

2. UNDERLYING PRINCIPLES

2.1 The MoW, DAWASA, RS and Municipalities agree that the following are the underlying principles that govern this partnership:

- (a.) Commitment to the fulfilment of the aspirations of the National Development Vision 2025;
- (b.) Compliance with defined budgeting, procurement and public financial management rules and regulations;
- (c.) Good governance and accountability of the Government to its citizens, including an active fight against corruption;
- (d.) Coordinating the implementation of the off-grid water supply and sanitation sub-projects cost effectively; and
- (e.) Each party executing its respective roles in a timely manner

3. GENERAL PROVISIONS

3.1 Purpose

This MoU outlines the responsibilities of the **MoW, DAWASA, RS and Municipalities** with respect to the implementation of off-grid water supply and sanitation sub-projects and sets forth common institutional, environmental and social measures, monitoring and evaluation, audit and reporting arrangements. The WSSP II Implementation Manual complements procedures and arrangements set out in this MoU.

3.2 **Status of the MoU**

This MoU is not intended to create any legally binding obligations and the parties take due cognizance of the separate sector laws and regulations between the Government Institutions, and this MoU is adopted pursuant to and subject to any such regulations. In case of any conflict between the provisions of this MoU and the project Financing Agreement, the provisions of the Financing Agreement shall prevail.

4. **OFF GRID WATER SUPPLY**

4.1. **Commitment**

The DAWASA declares its commitment to the objectives of the **Second Water Sector Support Project** and will act with due diligence and efficiency to facilitate the successful implementation of the projects. To this end, DAWASA, as an Implementing Agency will effectively carry out its roles and responsibilities in the implementation of the off-grid water supply and sanitation sub-projects as defined in the WSSP II Project Implementation Manual. The Ministry of Water, as the Responsible Agency for WSSP II will have overall responsibility for the coordination and implementation of the off-grid water supply and sanitation sub-projects.

4.2 **Institutional Arrangements**

The institutional framework for overseeing the implementation of the WSSP II comprises the following key bodies, as set out in the Sections below, and in greater detail in the WSSP Implementation Manual:

1. Ministry of Water;
2. Prime Minister's Office Regional Administration and Local Government;
3. Ministry of Health, Community Development, Gender, Elderly and Children
4. Municipal Councils
5. Beneficiary Communities ("BC");

4.2.1 **Ministry of Water (MoW)**

The MoW will be responsible for provision of overall coordination and oversight. The Ministry will also provide technical and administrative support in the implementation of WSSP II, including without limitation the following activities:

1. Coordinating and consolidating the quarterly WSSP II IFRs (Interim Financial Report); semi-annual and annual progress reports; and ensuring that funds earmarked for implementation of WSSP II activities are duly considered in the annual work plans

and budgets of the implementing agencies; and that the WSSP II procurement plans are consistent with WSSP II work plans and budgets;

2. Ensuring quality and consistency of the documents referred to in subparagraph (a) above prior to consolidation as indicated in the Programme Implementation Manual and submission to the Off-Grid WSS SC for discussion;
3. Monitoring the implementation of the Annual Work Plans and Budgets by the WSSP II Implementing Agencies, at least on quarterly basis;
4. Providing oversight on financial management, controls, audit and reports; and
5. Ensuring that management decisions made by the Off-Grid WSS Steering Committee are communicated to the Implementing Agencies, implemented and monitored.

4.2.2 DAWASA

DAWASA will be responsible for overall coordination and implementation of off grid water supply activities. The off-grid water supply shall be implemented under the Directorate of Infrastructure Development (for construction arrangements) in collaboration with the Communication Unit (for coordination arrangements). The Communication Unit will be generally responsible for:-

1. Coordinating inputs as required from other units within DAWASA such as Procurement, Technical Services, and Finance, etc.
2. Supervising and monitoring contracts / agreements
3. Setting up Sub-project Agreements with beneficiary communities
4. Monitoring and reporting overall progress of the off-grid water supply sub-component.
5. Reviewing and evaluating the operation and management of the water supply sub-projects.
6. The financial aspects for off- grid water supply sub-projects will be managed as per Project Implementation Manual VOLUME II, and
7. Overall supervision of off-grid water supply activities.

4.2.3 Municipal Councils (or DLGAs)

The five Dar es Salaam Municipal Councils, through their respective Urban Planning Department, Legal Unit, Municipal Health and Water Department, will be responsible for the following tasks:

1. Creating awareness and mobilization of the communities.

2. Each DLGA will form a Municipal Facilitation Team comprising different specialists from Water, Health, Education, Community Development departments that will be tasked to assist consultants/contractors/PO on implementation and operation of Off Grid Water Supply facilities in their respective areas.
3. DLGAs through Legal unit, Health and Water department will coordinate the formation of Water Supply by-laws and regulations and thereafter enforcing for sustainability of Off Grid Water Supply facilities.
4. DLGAs will be responsible for identification and facilitation of Land acquisition for construction of Off- Grid Water Supply facilities

4.2.4 WSS Steering Committee

Given the multiplicity of institutions with varying roles, a WSS Steering Committee (SC) will be set up under the project to ensure coordination, synergy, and dovetailing. This SC will be newly set up or be adopted from some of the other projects (for example, Dar es Salaam Metropolitan Development Program [DMDP]) which may have similar steering mechanisms. This steering committee will be chaired by the Head of the Water Sector from RS and DAWASA will provide the secretary to WSS SC.

The RS will chair the Off Grid WSS Steering Committee, which will be comprised of representatives from the DAWASA, RS, WRBO, MOW, DLGAs i.e Temeke, Ilala, Kinondoni, Kigamboni and Ubungo. The Steering Committee will be responsible for providing general oversight of the selection and approval of sub-projects for implementation by the Off-Grid Water Supply and Sanitation. The key responsibilities of the Off Grid WSS Steering Committee include:

1. Reviewing overall Off Grid Sanitation implementation arrangements
2. Reviewing and approving Off Grid Sanitation sub-project operational guidelines
3. Reviewing and approving Off Grid Sanitation sub-project proposals
4. Reviewing overall Off Grid Sanitation progress and performance and providing guidance for improvements if needed
5. Conflict Resolution as per PIM.

4.2.5 Beneficiary Community

At the project level, Beneficiary Community will be involved in the project appraisal, that includes identification of sources, selection of appropriate sites, kiosk locations, and

protection of water source and infrastructures. DAWASA will be responsible for the efficient operation and management of the water supply systems.

4.2.6 Private Operator

The Private Operator (PO) may be engaged if the expansion of DAWASA grid network is beyond five years away. The PO would primarily have as its members the households from the community, with an operating body selected by the members from among themselves, with additional membership from DAWASA/DLGA. The regulation of these systems, including the tariff, would be undertaken by EWURA, as part of the overall regulation of the sector in Dar es Salaam.

Private Operator will operate, maintain, and manage the scheme under contract with DAWASA.

The Private Operator shall be responsible for keeping and maintaining appropriate records of its business activities. These shall include:

1. Customer details
2. Operation and maintenance records including volume of water produced and sold
3. Asset register, work as executed records, manuals of plant and equipment
4. Condition and expected life of assets
5. The details of network expansions as up to standards.
6. The Private Operator shall prepare monthly and quarterly operation and maintenance
7. Reports for the completed off-grid water supply subproject
8. Billing and payment records
9. Business accounts and financial statement

In general, the Operation and Maintenance Reports will address such issues as:

1. Number of registered customers in the service area
2. Number of people in the service area and number of people served
3. Business plan and budget
4. Level of service; proposed and actual
5. Revenue and expenses, progress against budget
6. Customer satisfaction
7. Maintenance activities, breakdowns, failures
8. Availability of ground /reliable water sources
9. Availability for land resources for project activities
10. Manage non-revenue water in the business area

4.3 SELECTION CRITERIA

DAWASA, in consultation with the five municipalities Ilala, Temeke, Kinondoni, Kigamboni and Ubungu will identify communities which are eligible for the Off-Grid Water Supply sub-project under the WSSP II. The identification will follow the criteria below;

1. High population density
2. Low-income areas
3. Prevalence/risk of waterborne diseases
4. No wholesome water services
5. Near-trunk infrastructure
6. Availability of sufficient land for the interventions
7. Unplanned settlements
8. Community willingness

Each of these criteria will be allocated a score, and the communities prioritized according to their total score. Keeping in mind the decisions of other interventions (for example, The Dar es salaam Metropolitan Development Program - DMDP), WSSP-II will invest in those communities which have the highest need.

5.0 OFF-GRID SANITATION

5.1 Definition.

The Off-Grid Sanitation components will provide much needed improvements to wastewater management services in areas of Dar es Salaam that are not served by DAWASA network. These improvements will be realised as a result of construction of Off-Grid sanitation stand-alone projects such as Decentralized Waste Water Treatment Systems (DEWATSs), faecal sludge treatment facilities, and condominial/simplified sewerage. The Off-Grid Sanitation Services will address the lack of sanitation services in unserved areas.

5.2 Institutional Arrangements

A strategy to address the poor sanitation in Dar es Salaam requires clarity and coordination among the various institutions involved in the sector. However, institutional responsibility is fragmented and unclear, being divided between National Ministries, City Utilities, Municipal Organizations, Regulatory Authorities, Community-Based Organizations, the Informal Private Sector and sanitation users themselves.

Currently sanitation service delivery is undertaken by a mixture of Utilities, Municipalities and Regulators. DAWASA will be responsible for overall coordination and supervision of Off-Grid sanitation activities. Other institution as detailed in PIM are summarised below:

1. MoHCDGEC,
2. MoW,
3. RS,
4. DLGAs,
5. NGOs,
6. PO

5.2.1 Ministry of Water

Ministry of Water will be responsible with setting Policy and guidelines specific to FSM and overall project coordination and implementation support .

5.2.2 DAWASA

DAWASA will provide a foundation and resources for the overall implementation of Off-Grid Sanitation.

Directorate of Infrastructure Development will be the department within DAWASA responsible for overseeing the implementation of the WSSP II including Off-Grid Sanitation Sub component. The head of this department will report directly to the DAWASA Chief Executive Officer and will generally be responsible for:

1. Coordination of the Off-Grid Sanitation Steering Committee as well as establishing a general agenda and timetable for Steering Committee meetings with consultation with Steering Committee Chairperson and providing secretariat services.
2. Coordinating inputs as required from other Directorates within DAWASA such as Procurement, Infrastructure Development, and Finance, etc.
3. Signing, supervising and monitoring contracts / agreements
4. Setting up Sub-project Agreements with successful communities.
5. Monitoring and reporting overall progress of the Off-Grid Sanitation
6. Reviewing and evaluating the operation and management of the community sanitation schemes.

In support of Sub Component 3.2: a Sanitation coordination team led by PO-RALG - Regional Secretariat will be established to coordinate implementation of the Off- Grid sanitation services. The technical department in the municipalities in coordination with DAWASA will be responsible for implementation of the off-grid sanitation component. DLGAs through Health, Legal unit and Water departments will coordinate the formation or improvement of existing Sanitation by laws and regulations and thereafter enforcing them for the sustainability of Off Grid Sanitation facilities. Areas where these facilities will be built people will be required to connect. DLGAs will be responsible for identification and facilitation of Land acquisition for construction of Off- Grid Sanitation facilities, and management of Public toilets.

5.2.3 MoHCDGEC/MoW:
Policy and guidelines specific to FSM.

5.2.4 DLGAS under Regional Secretariat:

Roles and responsibilities of the DLGAs will include:

1. Creating awareness and mobilization of the community
2. Formulation of Municipal Facilitation Team comprised of specialists from Water, Health, Education, Community Development departments that will be tasked to assist consultants/Contractors/PO on implementation and operation of Off Grid Sanitation facilities
3. Coordination of the formation of Sanitation by-laws and regulations and thereafter enforcing them for sustainability of Off Grid Sanitation facilities through Legal unit, Health and Water Department
4. Identification and facilitation of land acquisition for construction of Off- Grid Sanitation facilities
5. Establish and capacitate the grievance redress mechanism (GRM) team
6. Monitor and evaluate project implementation, trouble shooting and responding to grievances raised by Grievance Redress Mechanisms (GRM) teams
7. Prepare and submit to WSS SC a monthly project implementation progress report

5.2.5 WSS Steering Committee

Given the multiplicity of institutions with varying roles, a WSS Steering Committee (SC) will be set up under the project to ensure coordination, synergy, and dovetailing. This SC will be newly set up or be adopted from some of the other projects (for example, Dar es Salaam Metropolitan Development Program [DMDP]) which may have similar steering mechanisms. This steering committee will be chaired by the Head of the Water Sector from RS and DAWASA will provide the secretary to WSS SC.

The RS will chair the Off Grid WSS Steering Committee, which will be comprised of representatives from the DAWASA, RS, WRBO, MOW, DLGAs i.e Temeke, Ilala, Kinondoni, Kigamboni and Ubungo. The Steering Committee will be responsible for providing general oversight of the selection and approval of sub-projects for implementation by the Off-Grid Water Supply and Sanitation. The key responsibilities of the Off Grid WSS Steering Committee include:

1. Reviewing overall Off Grid Sanitation implementation arrangements
2. Reviewing and approving Off Grid Sanitation sub-project operational guidelines
3. Reviewing and approving Off Grid Sanitation sub-project proposals

4. Reviewing overall Off Grid Sanitation progress and performance and providing guidance for improvements if needed
5. Conflict Resolution as per PIM.

5.2.6 Private Operator (PO):

The domestic private sector will be a major institution which will require to be involved for sanitation in low-income settlements. Their involvement will include approaches to empty faecal sludge from latrine pits and septic tanks. This could be through vacuum trucks, or in areas where access is difficult, small 'gulper' technologies.

Private Operator will form the basic unit for planning and eventually operating and managing the community-based sanitation schemes implemented under the off-grid sanitation. Off-grid sanitation POs, will be responsible for:

1. Possession of necessary registration as per requirements.
2. Undertaking training and development in operations and maintenance, financial management, monitoring and reporting.
3. Operating and maintaining the off-grid sanitation Scheme in a sustainable manner and providing equitable access to the service for everyone in the community
4. Maintaining adequate records and reporting on technical and financial performance to DLGAs and DAWASA.

5.2.7 NGOs/ Consultant:

NGO will be responsible for Capacity building, mobilization of community; media campaigns

DAWASA will contract with a reputable NGO active in the DAWASA service area as implementing agents for the off- grid Sanitation. The key roles of the off-grid sanitation NGO include:

1. Mobilising community groups to identify all sanitation needs and raising awareness within community groups about sanitation issues.
2. Assisting community members to obtain legal status if required and to set up the necessary bank accounts, for the community to qualify for funding from micro finance institution for toilet improvements.
3. Undertaking a needs analysis and preparing a subproject proposal design, budget, impact assessment, operational and maintenance of the sanitation facility
4. Preparing subproject proposals in association with the community members for consideration by the off-grid sanitation Steering Committee.
5. Sensitization and training of POs to operate, maintain, and manage off-grid sanitation systems.

6. Assisting DAWASA to develop suitable O&M guidelines/manuals and financial management guidelines for use by the POs in operating and managing the completed schemes.

5.3 SELECTION CRITERIA

DAWASA, in consultation with the five municipalities Ilala, Temeke, Kinondoni, Kigamboni and Ubungo will identify communities which are eligible for Off-Grid Sanitation sub-project under the WSSP II, in the eligible project area using the criteria mentioned in the PIM. The criteria will include the availability of land resources for the project activities as additional criteria.

Each of these criteria will be allocated a score, and the communities prioritized according to their total score. Keeping in mind the decisions of other interventions (for example, DMDP), WSSP-II will invest in those communities, which have the highest need.

The five municipalities will be the focal point for planning, prioritizing, and implementing the off-grid sanitation in their areas. A comprehensive master sanitation plan, based on empirical data and evidence, will form the basis for this planning and implementation.

The results of the ongoing efforts to map the city on the said indicators, will form the basis for the planning efforts by the stakeholders.

Summary of Institutional Roles for Sanitation Provision

MoH/MoW/PO-RALG	Policy and guidelines specific to FSM
MoW	Overall project coordination and implementation support
EWURA	Regulate performance of DAWASA
DAWASA	Facilitating the establishment and operation of treatment facilities (FSM and the like and facilitating the development of options for transportation and treatment of this waste, establishment and management of public toilets; regulating the services of transporters
Municipalities	Facilitating the upgrading of unimproved household toilets to improved ones and regulation of waste disposal; facilitating the availability of land for decentralized systems; provide licenses to private transport operators
Private sector	Development of infrastructure for transportation and treatment, operation
NGOs	Capacity building, mobilization of community; media campaigns

TBS	Setting up of standards for effluent disposal
NEMC	Regulation of disposal of effluent

6.0 EFFECTIVENESS AND DURATION OF MoU

- 6.1. This MoU will become effective on the date of signature by all parties.
- 6.2. This MoU shall remain in force until end Closure of the Second WSSP, or as shall be mutually agreed by the parties hereto.

7.0 AMENDMENTS

This MoU may be amended at any time with the written agreement of the parties hereto.

8.0 CONFLICT RESOLUTION

In the event of any differences arising with respect to the provisions of this MoU, the parties will endeavour to find a solution through dialogue and consultation.

9.0 INFORMATION AND NOTICES

- 9.1. The parties to this MoU will furnish to each other all such information in relation to the WSSP II as will be reasonably requested in a timely manner.
- 9.2. Any notices or documents given, made or sent by the parties in relation to this MoU will be in writing and will be deemed to have been duly given, made or sent to the organization or person to which it is addressed at the time of its delivery by hand, mail, or courier at its respective address, as listed in this MoU.
- 9.3. Any party hereto may, by written notice to the other parties, change the address to which any notice or request for the Participant so giving such notice will be addressed.
- 9.4. All communications and documents submitted to any party and by any part will be in the English language.
- 9.5. The following addresses are specified for purposes of Section 16.2.

9.6 FOR THE PARTIES

Permanent Secretary

Ministry of Water

Address

Tel:

E-mail:

Chief Executive Officer

DAWASA

Address

Tel:

E-mail:

Region Administrative Secretary

Dar es Salaam Region

Address:

Tel:

E-mail:

Municipal Director

Temeke Municipal Council

Address:

Tel:

E-mail:

Municipal Director

Ilala Municipal Council

Address:

Tel:

E-mail:

Municipal Director

Kinondoni Municipal Council

Address:

Tel:

E-mail:

Municipal Director

Ubungo Municipal Council

Address:

Tel:

E-mail:

Municipal Director







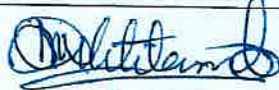

Kigamboni Municipal Council

Address:

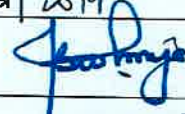
Tel:

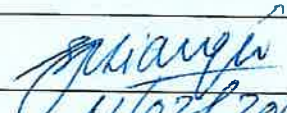
E-mail:

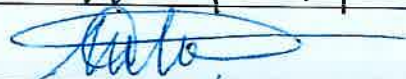
Signed by the duly authorized representatives of the parties as hereunder:

Permanent Secretary Ministry of Water	
	Date 18/2/2019
Regional Administrative Secretary Dar es Salaam	
	Date 1/2/2019
CEO DAWASA	
	Date 23.01.2019
Municipal Director Temeke	
	Date
Municipal Director Ilala	
	Date 11/02/2019
Municipal Director Ubungo	
	Date 07/02/2019
MD Kinondoni	
	Date 07/02/2019
Municipal Director Kigamboni	
	Date 09/02/2019

Appendix V: Architectural drawings

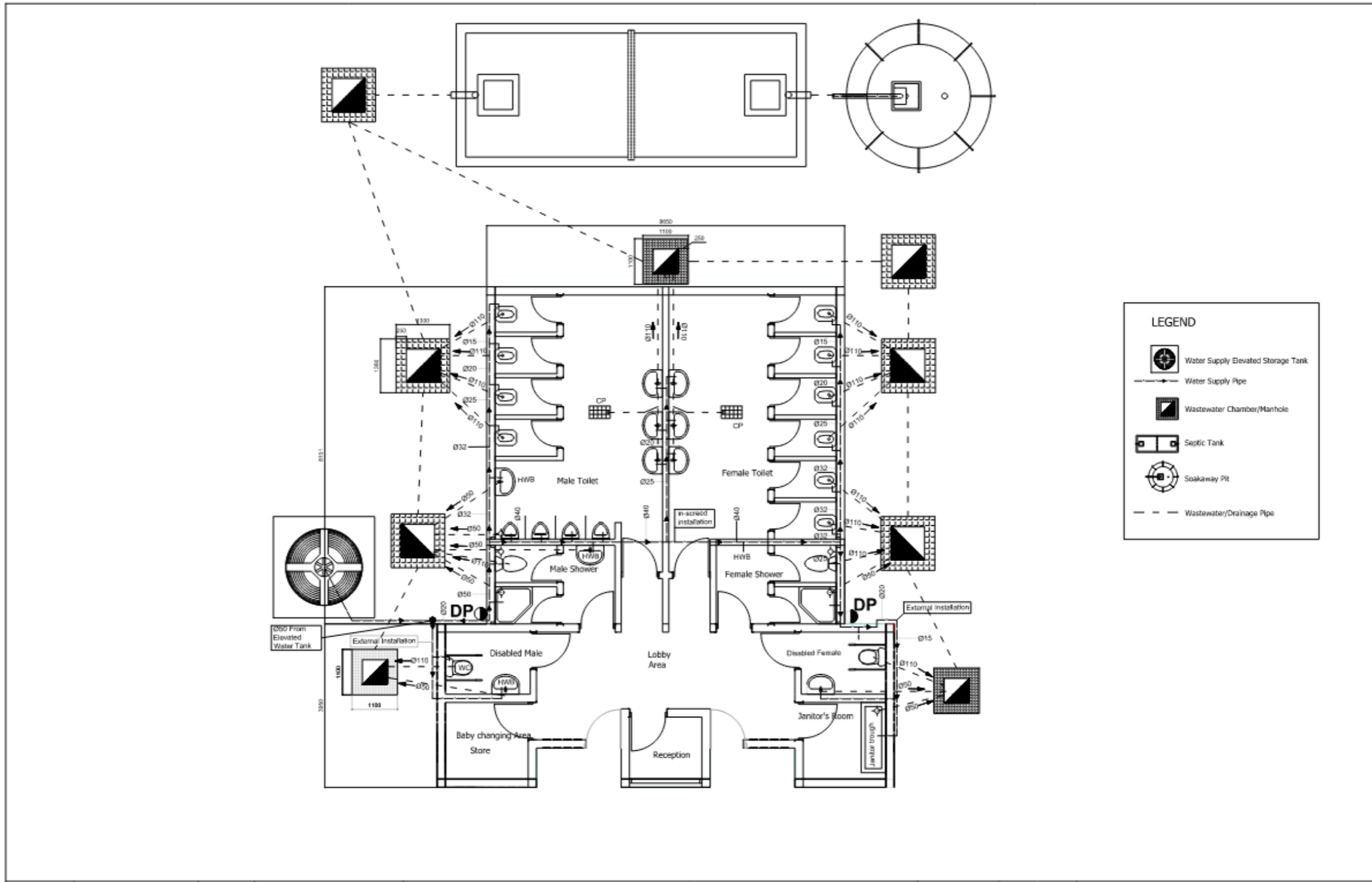

DESIGN BY		SCALE	1:80	PROJECT	PROVISION OF FACILITIES AND TECHNICAL SERVICES FOR CREATION OF ESSENTIAL FRAMEWORK CONDITIONS, CAPACITY BUILDING, PREPARATION OF DETAILED ENGINEERING DESIGNS AND BIDDING DOCUMENTS, AND CONSTRUCTION SUPERVISION OF THE OFF-GRID SANITATION WORKS IN DAR ES SALAAM	REVISION		CLIENT	DAR ES SALAAM WATER SUPPLY & SANITATION AUTHORITY (DAWASA)
DRAWN BY		DATE	APRIL-2021	TITLE	TYPICAL DRAWINGS FOR PUBLIC TOILET TYPE 3 FOR BUS STAND AREAS	DATE		CONSULTANT	DOHWA Engineering CO., LTD IN ASSOCIATION WITH LUPTAN CONSULTS LTD AND WWS
CHECKED BY		DRAWING NO.	PT-TYPC-209		WATER SUPPLY AND DRAINAGE DETAILS OF PUBLIC TOILET FOR 105-m ² GROUND TYPE	NATURE OF REV.			
APPROVED BY						CHECKED BY			
SHEET NO.						APPROVED BY			

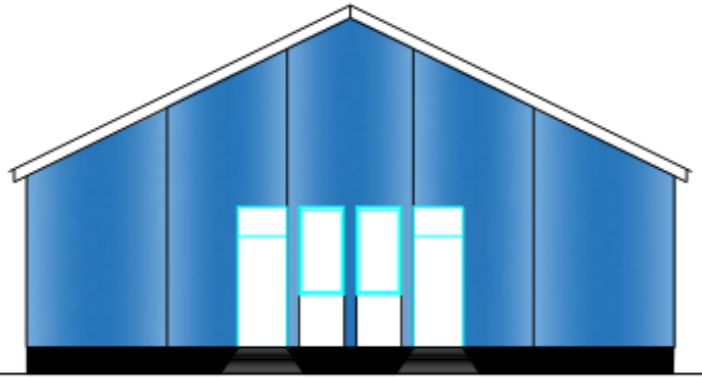

Front Elevation

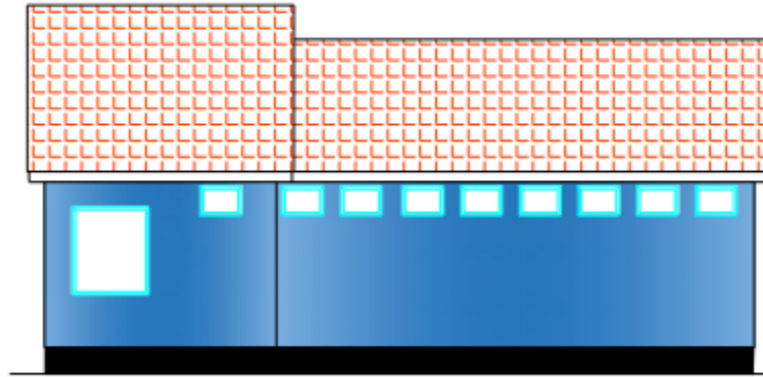

Right Side Elevation

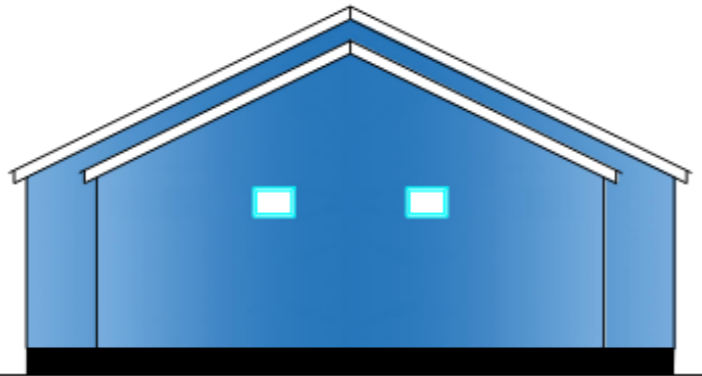

Rear Elevation

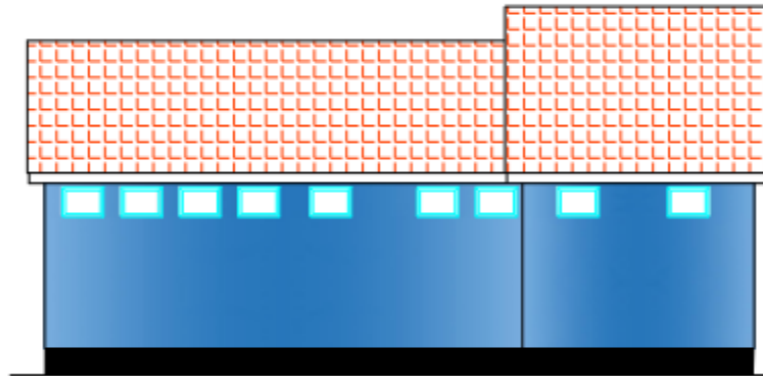

Left Side Elevation

NOTES:

1. ALL DIMENSIONS ARE IN MILLIMETERS UNLESS OTHERWISE SHOWN
2. DO NOT SCALE FROM THIS DRAWING
3. THE SCALES GIVEN ON THIS DRAWING REFER TO THE A1 SIZE ORIGINAL DRAWING
4. THE SUBGRADE SHALL BE COMPACTED TO 99% MAXIMUM DRY DENSITY BEFORE THE PLACEMENT OF HARDWARE
5. CONCRETE SHALL BE CLASS C30/37 FOR STRUCTURAL MEMBERS AND CLASS C8/10 FOR BLINDING
6. THE MAXIMUM SIZE OF AGGREGATE SHALL BE 20mm UNLESS OTHERWISE SHOWN
7. REINFORCEMENT SHALL BE HIGH TENSILE DEFORMED TYPE WITH A CHARACTERISTIC YIELD STRESS OF AT LEAST 429N/mm²
8. COVER TO REINFORCEMENT SHALL BE:
 - FOUNDATIONS 50mm
 - SLABS 25mm
 - WALLS AND BEAMS 30mm
9. LAPS TO ALL REINFORCEMENT SHALL BE 50 * BAR DIAMETER UNLESS OTHERWISE SHOWN

DESIGN BY		SCALE	1:100	PROJECT	PROVISION OF FACILITATION AND TECHNICAL SERVICES FOR CREATION OF ESSENTIAL FRAMEWORK CONDITIONS, CAPACITY BUILDING, PREPARATION OF DETAILED ENGINEERING DESIGNS AND BIDDING DOCUMENTS, AND CONSTRUCTION SUPERVISION OF THE OFF-GRID SANITATION WORKS IN DAR ES SALAAM	REVISION		CLIENT	DAR ES SALAAM WATER SUPPLY & SANITATION AUTHORITY (DAWASA)
DRAWN BY		DATE	APRIL-2021	TITLE	TYPICAL DRAWINGS FOR PUBLIC TOILET TYPE 3 FOR BUS STAND AND MARKET AREAS	DATE		CONSULTANT	DOHWA Engineering CO., LTD IN ASSOCIATION WITH LUPTAN CONSULTS LTD AND WWS
CHECKED BY		DRAWING NO.	PT-TYPC-202		ELEVATION VIEWS OF PUBLIC TOILET FOR 105m ² GROUND TYPE	NATURE OF REV.			
APPROVED BY						CHECKED BY			
SHEET NO.						APPROVED BY			

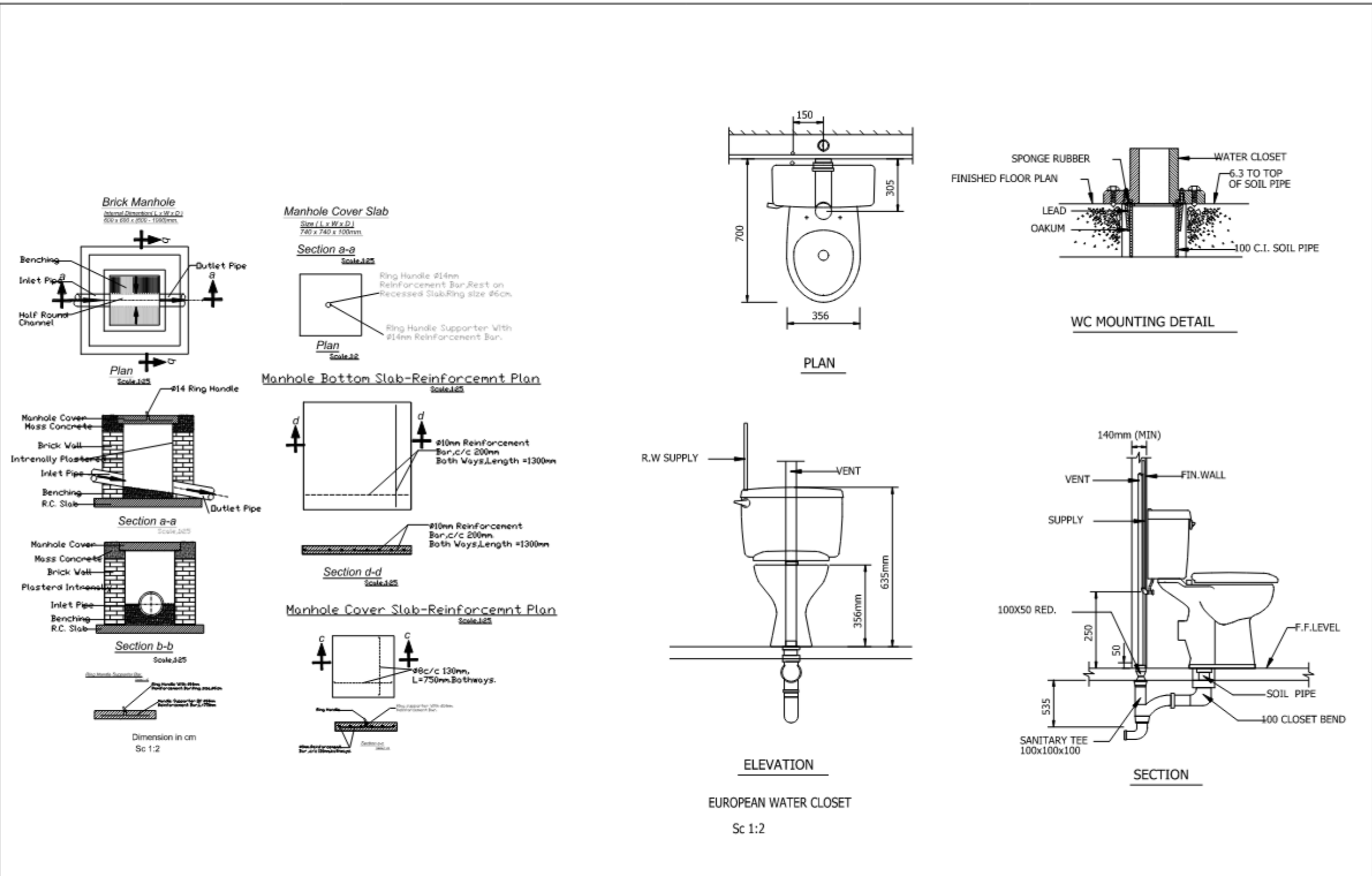

DESIGN BY		SCALE	AS SHOWN	PROJECT	PROVISION OF FACILITATION AND TECHNICAL SERVICES FOR CREATION OF ESSENTIAL FRAMEWORK CONDITIONS, CAPACITY BUILDING, PREPARATION OF DETAILED ENGINEERING DESIGNS AND BIDDING DOCUMENTS, AND CONSTRUCTION SUPERVISION OF THE OFF-GRID SANITATION WORKS IN DAR ES SALAAM	REVISION		CLIENT	DAR ES SALAAM WATER SUPPLY & SANITATION AUTHORITY (DAWASA)
DRAWN BY		DATE	APRIL-2021	TITLE	TYPICAL DRAWINGS FOR PUBLIC TOILET TYPE 3 FOR BUS STAND AREAS	DATE		CONSULTANT	DOHWA Engineering CO., LTD IN ASSOCIATION WITH LUPTAN CONSULTS LTD AND WWS
CHECKED BY		DRAWING NO.	PT-CDPT-401		WATER CLOSERS AND MANHOLES DETAILS FOR PUBLIC TOILETS	NATURE OF REV.			
APPROVED BY						CHECKED BY			
SHEET NO:						APPROVED BY			

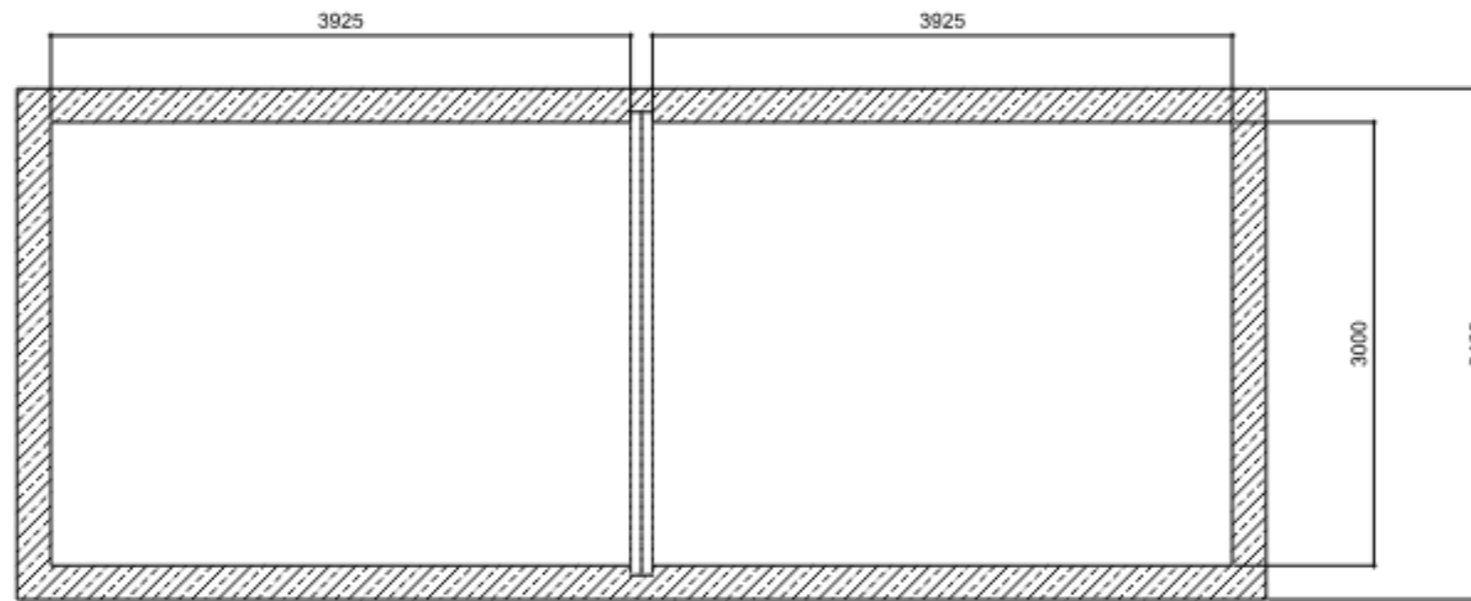

SECTION B-B
SCALE 1:30

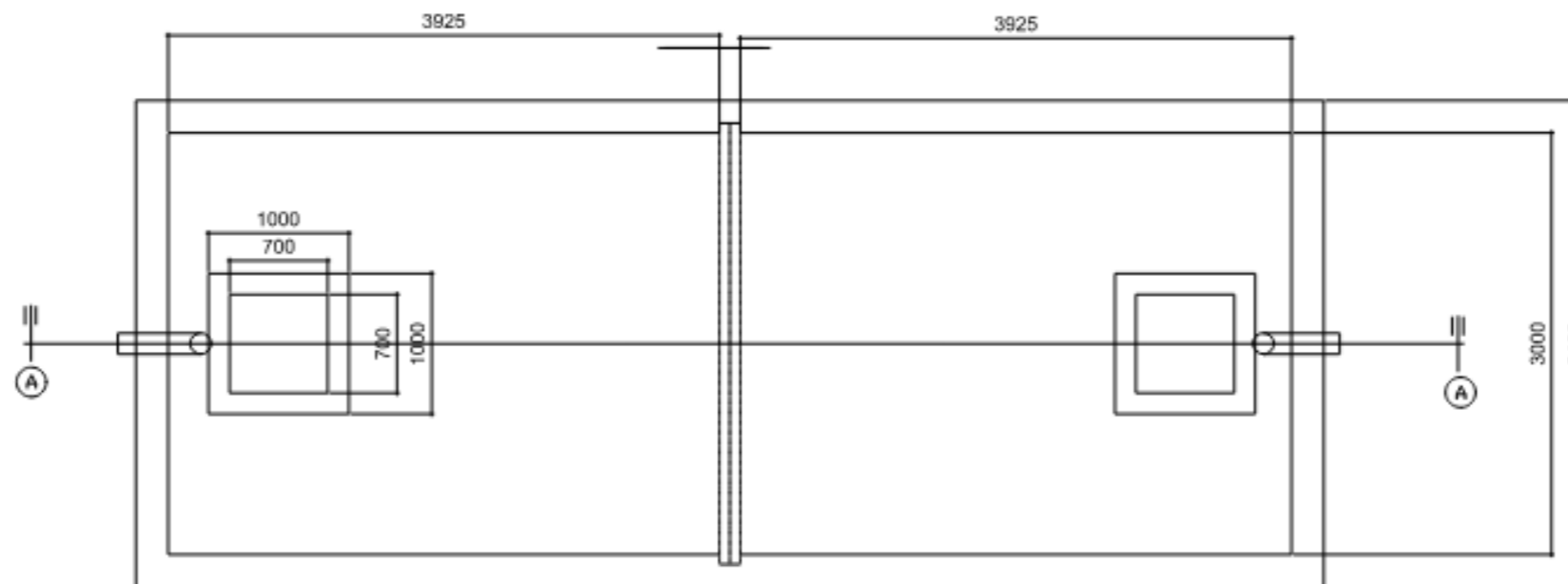

PLAN
SCALE 1:30

DESIGN BY		SCALE	1:30	PROJECT	PROVISION OF FACILITIES AND TECHNICAL SERVICES FOR CREATION OF ESSENTIAL FRAMEWORK, CONDITIONS, CAPACITY BUILDING, PREPARATION OF DETAILED ENGINEERING DESIGNS AND BIDDING DOCUMENTS, AND CONSTRUCTION SUPERVISION OF THE OFF-GRID SANITATION WORKS IN DAR ES SALAAM	REVISION		CLIENT	DAR ES SALAAM WATER SUPPLY & SANITATION AUTHORITY (DAWASA)
DRAWN BY				TITLE	TYPICAL DRAWINGS FOR PUBLIC TOILET TYPE 3 FOR BUS STAND AREAS	DATE		CONSULTANT	DOHWA Engineering CO., LTD IN ASSOCIATION WITH LUPTAN CONSULT LTD AND WWS
CHECKED BY		DATE	APRIL 2021			NATURE OF REV.			
APPROVED BY		DRAWING NO.	PT-CDPT-003			CHECKED BY			
SHEET NO.						APPROVED BY			

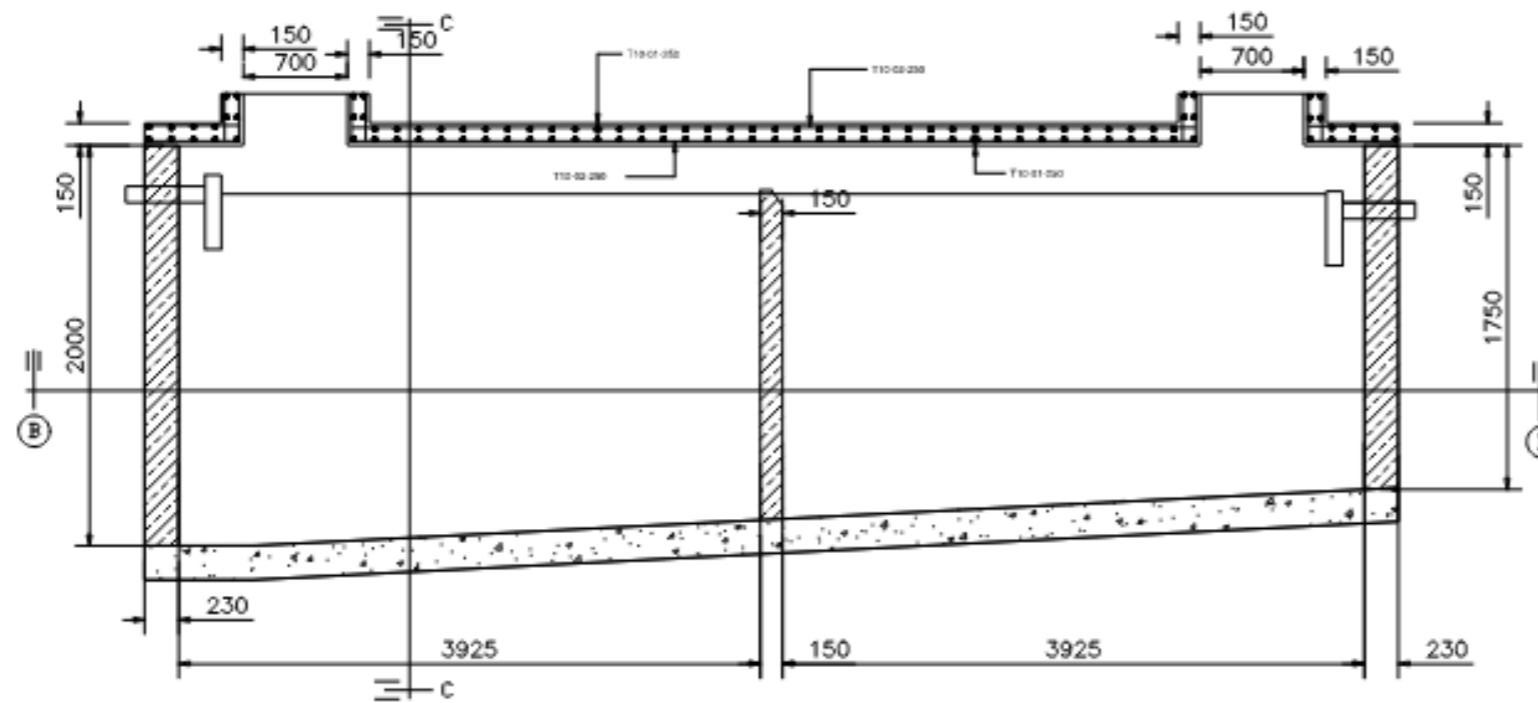

SECTION A-A
SCALE 1:40

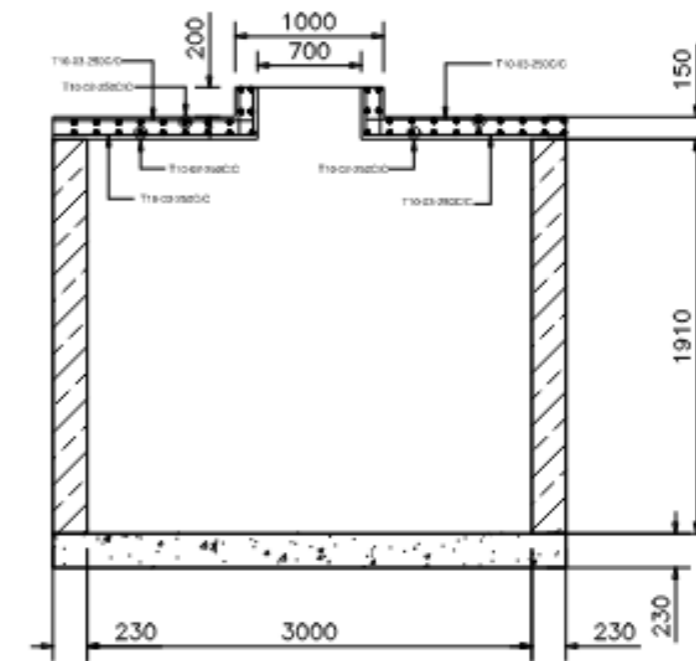

SECTION C-C
SCALE 1:40

DESIGN BY		SCALE	1:40	PROJECT	PROVISION OF FACILITIES AND TECHNICAL SERVICES FOR CREATION OF ESSENTIAL FRAMEWORK CONDITIONS, CAPACITY BUILDING, PREPARATION OF DETAILED ENGINEERING DESIGNS AND BIDDING DOCUMENTS, AND CONSTRUCTION SUPERVISION OF THE OFF-GRID SANITATION WORKS IN DAR ES SALAAM	REVISION		CLIENT	DAR ES SALAAM WATER SUPPLY & SANITATION AUTHORITY (DAWASA)
DRAWN BY						DATE	MAY-2021		
CHECKED BY		DATE	APRIL-2021	TITLE	TYPICAL DRAWINGS FOR PUBLIC TOILET TYPE 3 FOR BUS STAND AREAS	CHECKED BY		DOHWA	
APPROVED BY		DRAWING NO.	PT-CDPT-404						SEPTIC TANK SECTIONS AND REINFORCEMENTS DETAILS FOR PUBLIC TOILETS
SHEET NO.									

SOAKAWAY PIT-1 PLAN
Sc.1:25

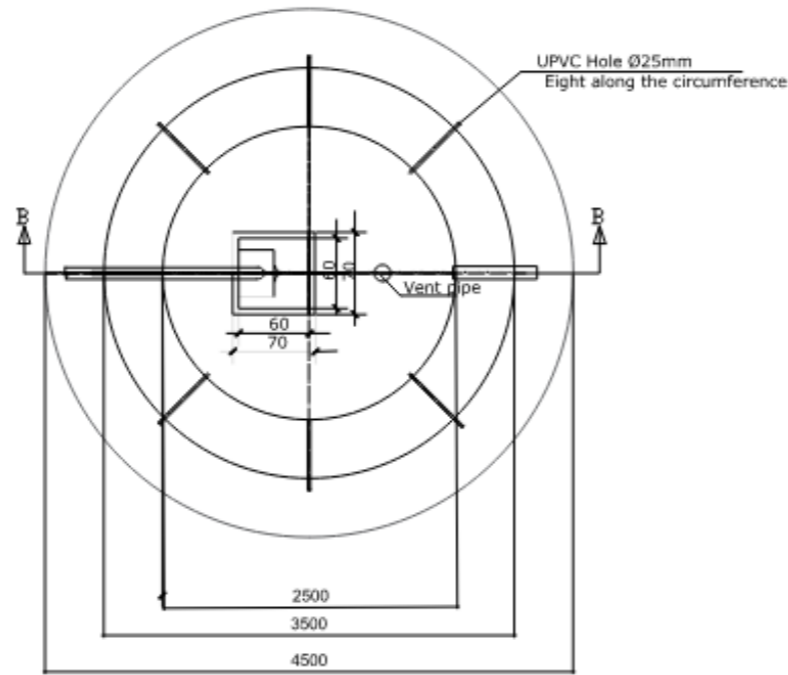

SOAKAWAY PIT
Sc.1:25

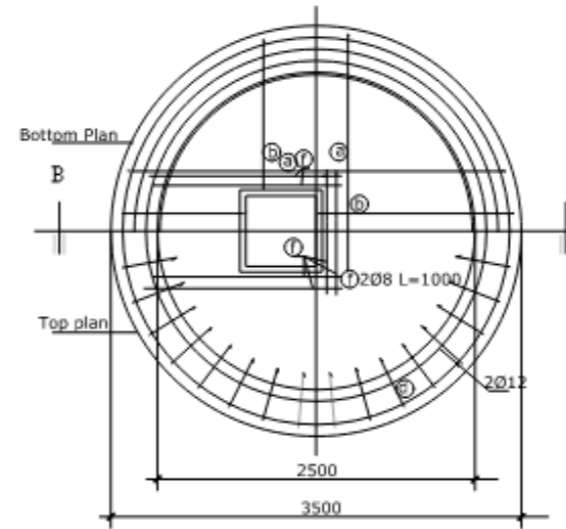

SECTION B-B
Sc.1:25

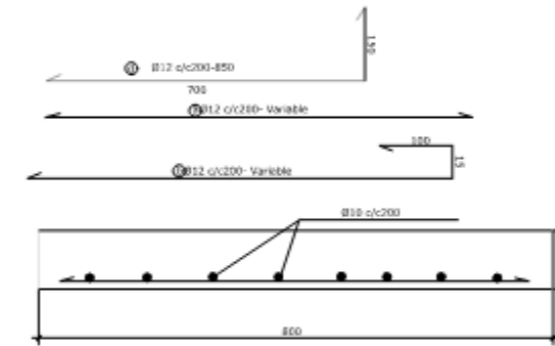
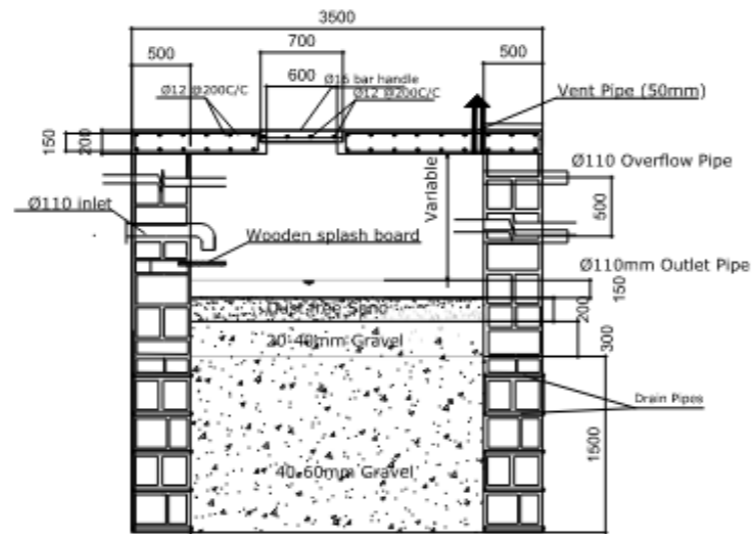

Cover Slab (RC)
SCALE 1:10

DESIGN BY		SCALE	1:50	PROJECT	PROVISION OF FACILITATION AND TECHNICAL SERVICES FOR CREATION OF ESSENTIAL FRAMEWORK CONDITIONS, CAPACITY BUILDING, PREPARATION OF DETAILED ENGINEERING DESIGNS AND BIDDING DOCUMENTS, AND CONSTRUCTION SUPERVISION OF THE OFF-GRID SANITATION WORKS IN DAR ES SALAAM	REVISION		CLIENT	DAR ES SALAAM WATER SUPPLY & SANITATION AUTHORITY (DAWASA)
DRAWN BY				TITLE	TYPICAL DRAWINGS FOR PUBLIC TOILET TYPE 3 FOR BUS STAND AREAS	DATE		CONSULTANT	DOHWA Engineering CO., LTD IN ASSOCIATION WITH LUPTAN CONSULTS LTD AND WWS
CHECKED BY					SOAKAWAY PIT GENERAL ARRANGEMENT, SECTIONS & REINFORCEMENTS DETAILS FOR PUBLIC TOILETS	NATURE OF REV.			
APPROVED BY		DATE	APRIL-2021			CHECKED BY			
SHEET NO.		DRAWING NO.	PT-COPT-405			APPROVED BY			

Appendix VI: Non-technical Summary

Muhtasari wa Mradi wa Mapendekezo ya Choo cha Umma kujengwa katika Bustani ya Magomeni, Kata ya Magomeni katika Manispaa ya Kinondoni -Mkoani Dar es Salaam.

Mmiliki: Dar es Salaam Water Supply & Sanitation Authority

Mawasiliano ya Mmiliki: DAWASA,

DAWASA Building, Dunga/Malaga Street,
Mwananyamala Area

S.L.P 1573, Dar es Salaam. TANZANIA.

Simu : +25522276006/15; Fax: +255222762480;

Barua Pepe: dawasaceo@dawasa.co.tz

Mshauri Muelekezi: Prof. Rubhera RAM Mato (PhD), CEng. (T), Reg.
EIA Expert

S.L.P 35478, Dar es Salaam, Tanzania

Simu: +255754898592

Barua Pepe: rubheramato@gmail.com

UTANGULIZI

SERIKALI ya Jamhuri ya Muungano wa Tanzania (GoT) kupitia Mamlaka ya Majisafi na Majitaka Dar es Salaam (DAWASA) chini ya Wizara ya Maji inatarajia kutekeleza Mradi wa Usafi wa Mazingira wa Nje (OGSP) katika Jiji la Dar es Salaam ili kuhudumia maeneo ya pembezoni mwa miji. haijaunganishwa na mfumo mkuu wa maji taka. DAWASA imepata ufadhili kutoka kwa Jumuiya ya Maendeleo ya Kimataifa (IDA) ikiwa ni mkopo wa kutekeleza mradi huo. Kabla ya kutekeleza mradi huo, sheria nchini Tanzania inataka Tathmini ya Athari kwa Mazingira ifanywe na kuidhinishwa na mamlaka husika. Ili kuzingatia sheria nchini Tanzania, DAWASA inatarajia kutumia sehemu ya mapato ya mikopo kwa malipo stahiki kwa ajili ya huduma za ushauri kwa ajili ya Maandalizi ya Tathmini ya Athari kwa Mazingira na

Kijamii (TAM) na Ripoti ya Mpango Kazi wa Makazi Mapya (RAP) kwa ajili ya ujenzi ya miradi ya usafi wa mazingira nje ya gridi ya taifa.

Mradi huu unakusudiwa kutatua changamoto hizi. Mradi wa Off-Grid umegawanywa katika miradi midogo kadhaa ambayo itatekelezwa katika manispaa tano za Jiji la Dar es Salaam. Mojawapo ni Ujenzi wa Choo cha Umma katika Bustani ya Magomeni, Kata ya Magomeni katika Manispaa ya Kinondoni. Choo hicho kitahudumia zaidi watu wanaofanya biashara karibu na eneo hilo (Wafanyabiashara na wateja wao), wauzaji wa vyakula (Mamantilie) na wapita njia.

SERA, MFUMO WA SHERIA NA TAASISI

Tanzania imejitolea kufikia malengo ya maendeleo endelevu. Msukumo huu unazingatiwa katika Sera ya Taifa ya Mazingira na sera nyingine za kissekta zikiwemo;

- Sera ya Kitaifa ya Mazingira, 2021
- Sera ya Taifa ya Ardhi ya mwaka 1997
- Sera ya Sekta ya Ujenzi (2003)
- Sera ya Taifa ya Afya (2003)
- Sera ya Taifa ya Jinsia ya 2000
- Sera ya Taifa ya Maendeleo ya Makazi (2000)

Sheria na kanuni muhimu ambazo zina umuhimu kwa maendeleo ya barabara kuhusiana na usimamizi wa mazingira ni pamoja na;

- Sheria ya Usimamizi wa Mazingira (2004)
- Kanuni za Usimamizi wa Mazingira (Ada na Ada) za 2021
- Kanuni za Usimamizi wa Mazingira (Udhibiti wa Taka hatarishi), 2021
- Kanuni za Usimamizi wa Mazingira (Udhibiti wa Kelele na Mtetemo), 2015
- Kanuni za Usimamizi wa Mazingira (Marufuku ya Mifuko ya Kubeba Plastiki), za 2019
- Kanuni za Usimamizi wa Mazingira (Udhibiti wa Taka Ngumu), 2007

- Kanuni za Usimamizi wa Mazingira (Ubora wa Maji), 2009
- Kanuni za Usimamizi wa Mazingira (Ubora wa Hewa), 2009
- Kanuni za Usimamizi wa Mazingira (Ubora wa Udongo), 2009
- Sheria ya Afya na Usalama Kazini ya 2003
- Sheria ya Ugavi wa Maji na Usafi wa Mazingira Na. 12 ya 2009
- Sheria ya Usajili wa Wahandisi na Marekebisho yake ya 1997 na 2007
- Sheria ya Usajili wa Makandarasi (Marekebisho) ya mwaka 2008
- Sheria ya Wabunifu na Wakadiriaji Majenzi (1997)
- Sheria ya Mipango Miji (2007)
- Sheria ya Afya ya Umma (2009)
- Miongozo ya Benki ya Dunia ya Usimamizi wa Mazingira

MAELEZO YA MRADI

Shughuli kuu za ujenzi wa miradi midogo ni pamoja na;

- **Usafishaji wa Maeneo:** Mkandarasi atasafisha maeneo ya ujenzi ndani ya tovuti ya mawe yote, vizuizi vya asili, takataka na vizuizi vyovyote vya asili au vya bandia, ambavyo vitaingilia ujenzi wa majengo, barabara, njia na mifereji ya maji.
- **Uchimbaji:** Uchimbaji wa misingi na muundo wa saruji iliyoimarishwa utakuwa wa upana, kina na ngazi ili kuzingatia muundo ulioonyeshwa kwenye michoro. Nafasi ya kufanyia kazi imeruhusiwa kwa ajili ya kupima kiasi cha uchimbaji kilichotolewa katika Miswada hii ya Viwango kwa mujibu wa kanuni za kipimo zilizowekwa mahali pengine katika Miswada hii, yaani mita 1.00 kutoka eneo la kazi yoyote ambayo inahitaji uundaji wa kina cha zaidi ya mita 1 chini ya mwanzo. kiwango cha uchimbaji, na mita 0.30 kutoka uso wa kazi yoyote ambayo inahitaji formwork isiyozidi mita 1-kina chini ya ngazi ya kuanzia ya uchimbaji.
- **Kujaza kifusi:** Kifusi kiitakuwa safi, mchanga mgumu uliochaguliwa au changarawe. Inapaswa kuchukuliwa kutoka kwa mashimo ya kukopa ikiwa udongo kwenye tovuti unapatikana kuwa na faini nyingi na kuwa na kikomo cha chini cha plastiki kutumika kama kujaza.

- **Utunzaji wa Udongo:** Matibabu ya kuzuia mchwa yatafanywa na kampuni ya kitaalam iliyoidhinishwa ambayo itahitajika, baada ya kukamilika kwa kufungia udongo, kutoa hati ya maandishi ya kuhitimu ambayo inajumuisha; kemikali zinazotumika zinakidhi mahitaji na mkusanyiko, matibabu yatabaki kuwa na ufanisi dhidi ya wadudu wa mchwa kwa muda wa miaka mitano na pia matibabu ya bure na kampuni ya maeneo yoyote yanayoonyesha dalili za kushambuliwa kabla ya kumalizika kwa kipindi cha miaka mitano. .
- Utupaji wa ziada ya kifusi zilizochimbwa: kifusi kilichochimbwa zaidi zitatolewa kutoka karibu na kuta na kuwekwa, kutawanywa na kusawazishwa kwenye maeneo yatakayotengwa na Mhandisi wa Miundo, karibu na tovuti.
- Kazi ya zege
- Ufungaji wa chuma na Foroma

MAZINGIRA YA MRADI

Eneo la mradi

Eneo la tovuti liko katika ukanda wa pwani wa kitropiki wa Tanzania na huathiriwa na misimu miwili mikuu ya hali ya hewa, ambayo ni mvua na joto. Mpangilio wa mvua ni ule wa aina mbili na mvua za kawaida zisizo na uhakika. Mvua za masika zinazonyesha karibu katika Manispaa nzima kati ya Desemba na Februari, Wakati mvua kubwa za muda mrefu katika kipindi cha Machi hadi Juni, kiasi cha mvua zilizopatikana ni kati ya Milimita 800-1200 kwa mwaka. Halijoto kama vile mvua pia huathiriwa na bahari. Joto la juu hutawala mwaka mzima kuanzia nyuzijoto 25⁰C katika kipindi cha Juni hadi Agosti hadi Nyuzi joto 35⁰C katika kipindi cha Januari hadi Machi.

Vyanzo vya maji

Maji ya chini ya ardhi ni mengi karibu katika Jiji zima la Dar es salaam. Hii inathibitishwa na ukweli kwamba visima vifupi ni moja ya vyanzo vya maji ya majumbani kwa kaya nyingi zinazozunguka eneo la mradi na kwa hivyo kiwango cha maji ni kikubwa.

Ubora wa hewa na kiwango cha Kelele

Uchunguzi wa ubora wa hewa unaonyesha kuwa hali ya hewa kwa ujumla katika eneo la mradi ni nzuri kwani hakuna shughuli yoyote ya ajabu inayochangia uchafuzi wa hewa. Hata hivyo, mabadiliko ya msimu pamoja na kuzorota kwa hali ya hewa ya ndani na ya muda hutokea.

Kwa upande mwingine, kiwango cha kelele katika eneo la mradi ni hasa kutokana na kusonga gari kando ya barabara, kusonga hewa (upepo) au mvua na ndege. Shughuli za mradi wakati wa ujenzi zitabadilisha mwelekeo na amplitude ya kelele katika eneo la mradi.

Mimea

Maeneo ya mradi yaliyopendekezwa yana sifa ya uoto wa bandia wachache ikiwa ni pamoja na senna seamea na baadhi ya mimea michache ya mwarobaini karibu na eneo la mradi.

WADAU WA MRADI NA USHIRIKISHI

Mbinu rahisi ilipitishwa ili kubainisha washikadau wakuu na maswala makuu ya kimazingira na kijamii. Hii ilihusisha uchunguzi wa kimwili na mashauriano (mashauriano ya moja kwa moja). Taarifa nyingine kuhusu mradi huo zilipatikana kupitia utafiti wa dawati.

Wakati wa kufanya utafiti huu, wadau mbalimbali walishauriwa. Miongoni mwao ni pamoja na Halmashauri ya Manispaa ya Ilala na jumuiya katika Kituo cha Mabasi cha Chanika. Katika mkutano huo, mshauri huyo alitoa maelezo mafupi kuhusu pendekezo la choo cha umma.

ATHARI MUHIMU ZINAZOWEZEKANA KWA MAZINGIRA NA KIJAMII

Athari zimeainishwa katika athari za awamu ya Uhamasishaji, athari za awamu ya Ujenzi, na athari za awamu ya Uendeshaji. Vipokezi vikuu vya athari zinazohusiana na Ujenzi unaotarajiwa wa Choo cha Umma katika Soko la Shekilango, kata ya ubungo katika Manispaa ya Ubungo ni pamoja na rasilimali asili (ubora wa maji chini ya ardhi, udongo, ubora wa hewa na

kelele); rasilimali za kiikolojia (mimea); mali, afya ya umma, na usalama, aesthetics, na mazingira.

Athari zifuatazo zilitambuliwa kuwa zinaweza kutokea wakati wa Awamu ya Uhamasishaji

- Fursa za ajira
- Uchafuzi wa kelele
- Uchafuzi wa Hewa kutokana na uchafuzi wa vumbi

Athari zifuatazo zilitambuliwa kuwa zinaweza kutokea wakati wa Awamu ya Ujenzi

- Fursa za ajira
 - Kuboresha hali ya maisha na ukuaji wa uchumi
 - Kuboresha afya ya umma
 - Kuongezeka kwa mwingiliano wa kijamii na kitamaduni
 - Ongezeko la Mapato kwa taifa kupitia kodi, za moja kwa moja na zisizo za moja kwa moja
 - Kuongezeka kwa VVU/UKIMWI na magonjwa mengine yanayohusiana na ngono:
 - Uharibifu na ukiukaji wa mali
 - Uchafuzi wa kelele
 - Uchafuzi wa Hewa kutokana na uchafuzi wa vumbi
 - Uwezekano wa maambukizi ya magonjwa ya kuambukiza
 - Hunuka na nzi kwenye vyoo
 - Hatari kubwa ya Afya inayohusishwa na kazi ya ujenzi
 - Uzalishaji wa taka wakati wa ujenzi
 - Uchafuzi wa maji chini ya ardhi kutokana na kufungia udongo
-
- Athari zifuatazo zilibainishwa kuwa zinaweza kutokea wakati wa Awamu ya Operesheni
 - Kuboresha maisha ya kijamii na kiuchumi na heshima ndani ya jamii inayofaidika

- Ongezeko la Mapato kwa taifa kupitia kodi, za moja kwa moja na zisizo za moja kwa moja
- Hunuka na nzi kwenye vyoo

KINGA NA USIMAMIZI WA AJALI WAKATI WA HATUA YA UTEKELEZAJI

Mradi utatekelezwa kwa kufuata sheria za kazi nchini Tanzania, hususan, Sheria ya Afya na Usalama Kazini (2003). Vifungu vya kulinda afya na usalama wa wafanyikazi vitajumuishwa katika hati za mkataba kwa hatua ya utekelezaji ambayo ni pamoja na yafuatayo; utoaji na utekelezaji wa matumizi ya vifaa vya kinga binafsi vinavyofaa kwa wafanyakazi wote k.m. ovaroli, glavu, barakoa, n.k. (popote inapohitajika), uwepo wa mpango wa maandalizi ya dharura uliowekwa kabla ya kuanza kwa shughuli za ujenzi na vile vile kuhakikisha usalama wa tovuti kwa kuzungushia uzio eneo lote la mradi na kutoa milango kwa madhumuni ya kuingilia na kutoka. .

HATUA ZA KUPUNGUZA NA MPANGO WA USIMAMIZI WA MAZINGIRA NA KIJAMII

Chaguzi za kupunguza au kuzuia athari mbaya za kijamii na kimazingira zilizotambuliwa pamoja na mpango wa ufuatiliaji zimependekezwa katika ripoti hii na zimo katika ESMP. Wengi wao ni msingi wa mazoea mazuri ya uhandisi na mwitikio wa wakati wa taasisi inayohusika. ESMP inaeleza ratiba ya utekelezaji wa mapendekezo ya hatua za kupunguza na pia kupanga shughuli za ufuatiliaji wa muda mrefu. Inafafanua majukumu na wajibu wa watendaji mbalimbali wa mpango. Gharama za Mbinu za kimazingira na kijamii ni TSH 38,000,000 (Bila gharama zitakazoonekana katika bajeti ya ujenzi wa mradi) na zoezi la makazi mapya. Makisio ya gharama za kila mwaka za kufuatilia mapendekezo ya mpango wa kutunza mazingira na jamii ni TSH 24,000,000.

HITIMISHO

Hivyo basi, imehitimishwa kuwa utekelezaji wa mapendekezo ya ujenzi wa vyoo vya Umma katika Bustani ya Magomeni, Kata ya Magomeni katika Manispaa ya Kinondoni hautaleti madhara yoyote isipokuwa kwamba hatua zinazopendekezwa za kupunguza makali zimewekwa ipasavyo na kwa

wakati. Athari mbaya zilizotambuliwa zitadhibitiwa kupitia hatua zilizopendekezwa za kupunguza na mfumo wa utekelezaji uliowekwa katika ripoti ya TAM. DAWASA imejitolea kutekeleza mapendekezo yote yaliyotolewa katika ripoti na kutekeleza zaidi ratiba za ukaguzi na ufuatiliaji wa mazingira.

Appendix VII: Screening Letter from NEMC



**NATIONAL ENVIRONMENT MANAGEMENT COUNCIL(NEMC)
BARAZA LA TAIFA LA HIFADHI NA USIMAMIZI WA MAZINGIRA**

Telephone: +255 22 2774889,
Direct line: +255 22 2774852
Mobile: 0713 608930
Fax: +255 22 2774901
Email: dg@nemc.or.tz
Website: www.nemc.or.tz

35 Regent Street,
P. O. Box 63154
11404 Dar es Salaam
TANZANIA

Date: 09/04/2021

Director General;
Dar es Salaam Water Supply and Sanitation Authority,
P. O. Box 1573,
Dar es Salaam.

RE: SCREENING DECISION FOR THE PROPOSED ESTABLISHMENT OF PUBLIC TOILET TO BE LOCATED AT MAGOMENI GARDEN, MAGOMENI WARD, KINONDONI MUNICIPALITY IN DAR ES SALAAM REGION

Reference is made to the above heading.

2. The Council has received your Project Brief for the aforementioned project on 31st August 2020. Following the review of the submitted project brief, the Council has reached a decision that your project falls under B2 types of projects and hence does not require full Environmental Impact Assessment study.
3. In this regard you will be required to submit Detailed Project Brief with the following taken into account;
 - i. All copies of relevant documents including certificate of occupancy bearing the name of the proponent, the land use plan of the plot, block and plot number. In the title page include plot and block numbers, the long term of DAWASA should be Dar es Salaam Water Supply and Sanitation Authority and not the one provided in the proponent section;
 - ii. Detailed description on each component with their associated infrastructures expected to be onsite during the project implementation;

All correspondence should be addressed to the Director General

- iii. Describe in detail the proper management of the waste water from toilets, capacity of the onsite treatment facilities, provide the specific treatment plant which will be used to treat sludge and stabilization ponds where sludge will be disposed after treatments;
- iv. Provide current baseline data including water table around the project site;
- v. Detailed information of Solid and Hazardous Waste Management to be practiced in the project site and provide the expected final disposal area;
- vi. Describe storm water management practice expected to be onsite during project implementation;
- vii. Append site layout plan showing all project components in relation to the size of the plot as per Urban Planning (Urban planning (use groups and use classes) Regulation 2018. The architectural design signed by the relevant authority should also be appended in the report;
- viii. Detailed key stakeholder's including neighbours surrounding the proposed project area (including but not limited to TANESCO, DART, Church), LGAs (Mtaa, Ward), Kinondoni Municipal Council (Town Planning and Land Departments, sanitation and Environment Management Unit) who are pertinent to the project should be consulted; their views and concerns should be addressed. Minutes of the meetings (**attached with pictures**) taken during the meeting should be provided in the report. Consultation forms should bear recent **date** of consultation and each consulted stakeholder should **sign** against his/her **name** as the law requires;
- ix. Upon submission of the Detailed project Brief and payment of the review charges you will be required to incur **transportation cost for the site visit team to and from the project site.**

4. Furthermore, be reminded that the project brief should conform to the EIA and Audit (Amendment) Regulations, 2018 particularly Regulation 6(1) for the content of the comprehensive project brief.

Yours Sincerely,

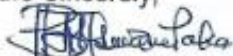

Eng. Benjamin J. Mchwampaka.

For: Director General

All correspondence should be addressed to the Director General

Cc: Prof, Rubhera RAM Mato (PhD)
P.O. Box 35176,
Dar es Salaam.
E-mail:rubheramato@gmail.com

All correspondence should be addressed to the Director General
